

WOODY VASUKA
RTG BOX 100
SANTA FE NM

1700

FOLKER C

912

TELEVISION

920

2/13/85
GEORGE BROWN

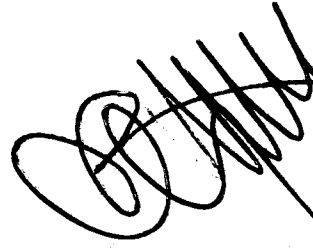

SINCE OUR CONVERSATION ON SUNDAY,
I HAVE 'UNEARTHED' SOME MULTIKEYER ETCHINGS.
ARE YOU INTERESTED?

I HAVE ENCLOSED THE \$130 CHECK
WE DISCUSSED.

SAY HI TO STEINA.

YOURS TRULY

GEORGE

GEORGE BROWN:

VIDEO MULTIKEYER

PASSIVE MATRIX (PIN-11) 11 X 11

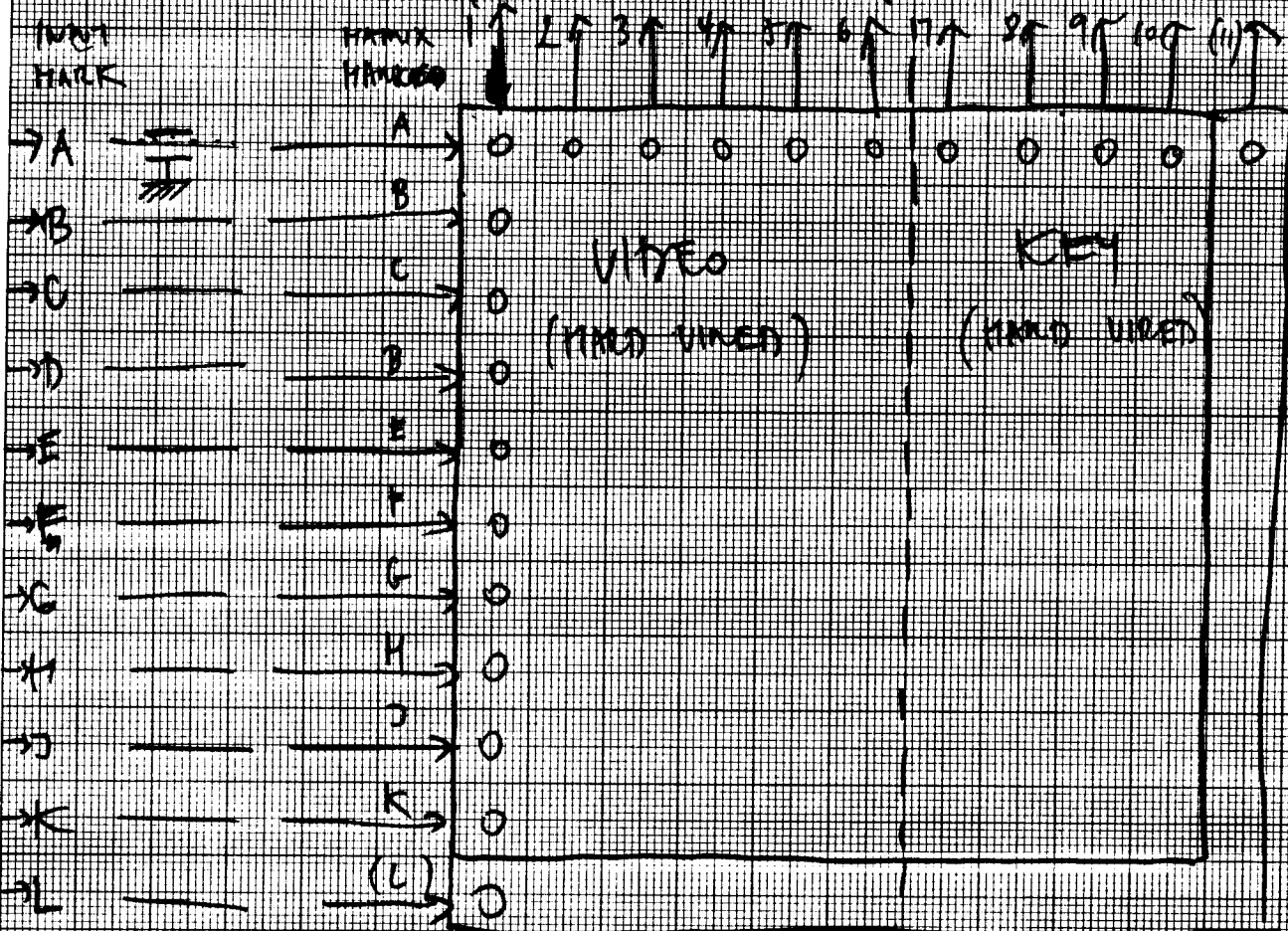

BNC

- A } EXTERNAL
- B } TTL INPUTS
- SYNC (IN IM. MODE INPUT A VIDEO PROVIDES SYNC)
- +12 VOLTS

$$\frac{5.3 \times 10^{-3}}{0.7} = 7.57$$

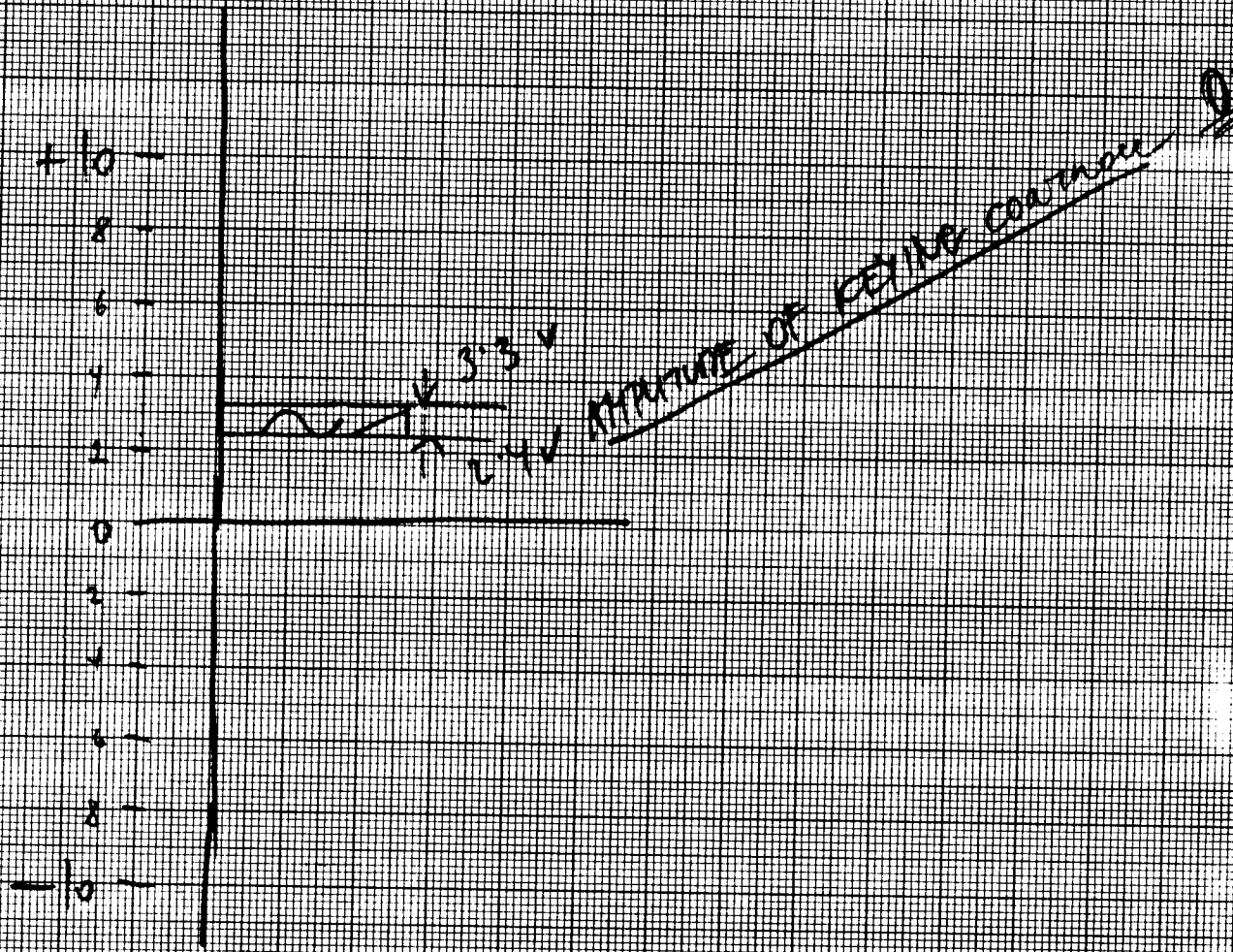

VIF50 LEVEL:

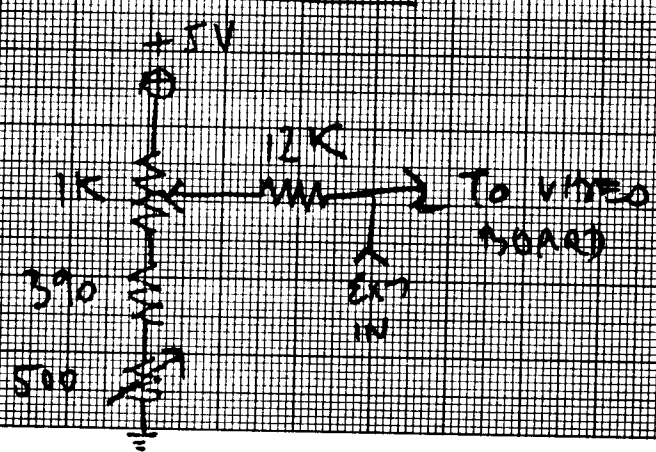

VIF10 LEVEL:

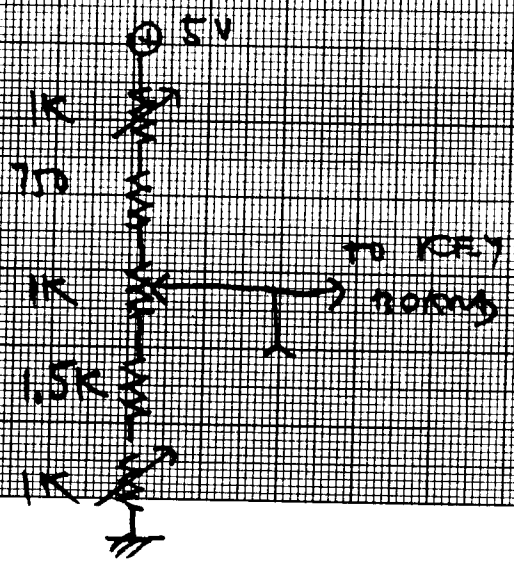

④

OK

- 1.2.3.4
- 2.1.3.4
- 3.2.1.4
- 4.3.2.1

- 4.3.2.1
- 4.2.3.1
- 4.1.3.2
- 4.3.1.2
- 4.2.1.3
- 4.1.2.3

- 4.3.2.1 OK
- 4.3.1.2 NG
- 4.2.1.3 NG
- 4.2.3.1 OK
- 4.1.2.3 NG
- 4.1.3.2 NG

①

2

③

- 1.2.3.4 OK
- 1.2.4.3 OK
- 1.3.4.2 NG
- 1.3.2.4 OK
- 1.4.3.2 OK
- 1.4.2.3 NG

- 2.1.3.4 OK
- 2.1.4.3 OK
- 2.3.4.1 NG
- 2.3.1.4 NG
- 2.4.3.1 NG
- 2.4.1.3 NG

- 3.2.1.4 OK
- 3.2.4.1 NG
- 3.1.4.2 NG
- 3.1.2.4 NG
- 3.4.2.1 NG
- 3.4.1.2 NG

VIDEO LEVEL

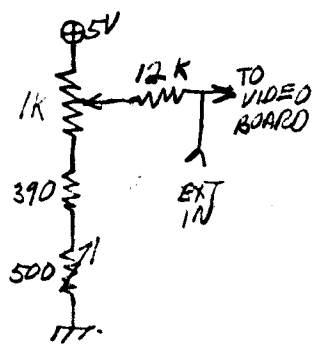

KEY LEVEL

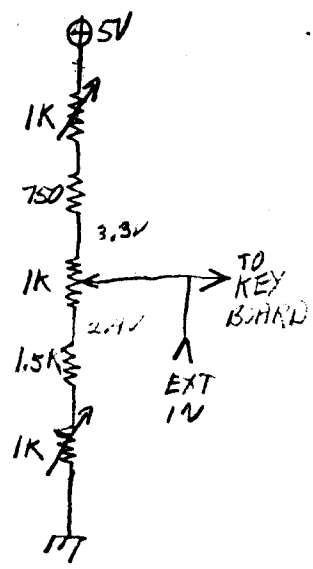

ADD

7442

74155

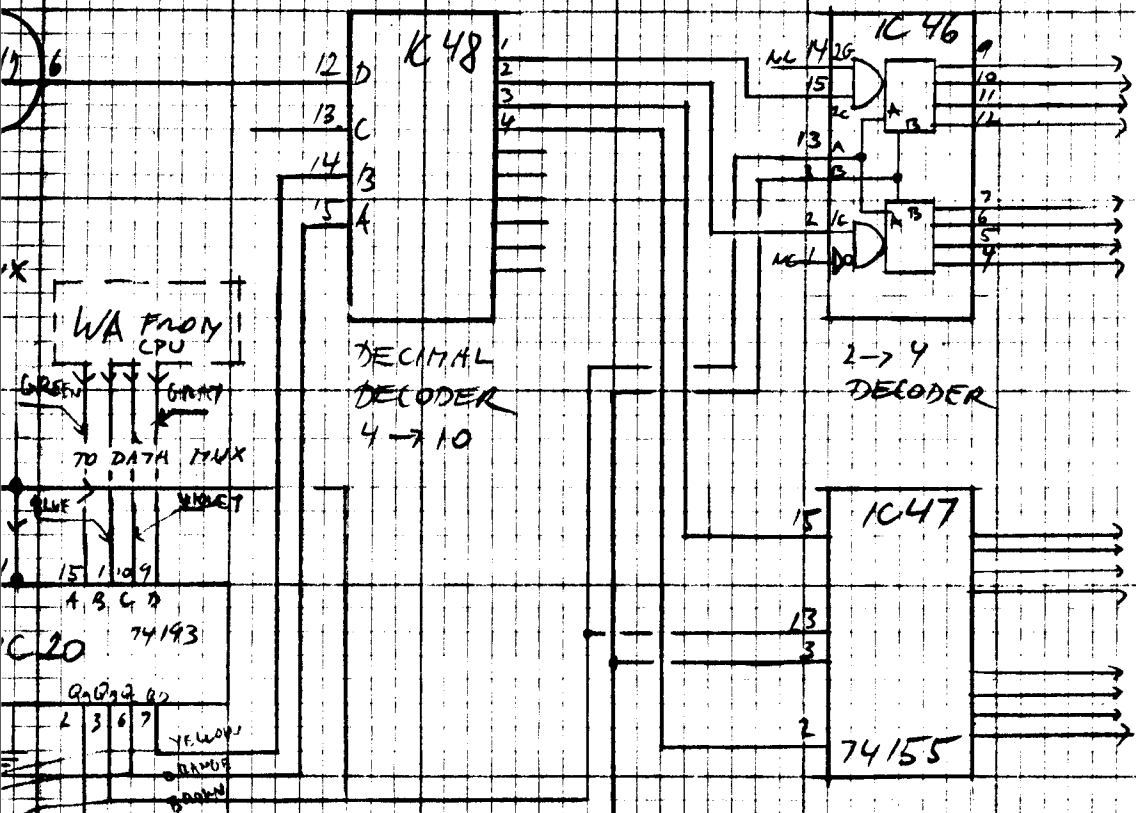

WE TO THE MEMORY

WE TO SCALAR MEMORY AND NEXT ADDRESS REGISTER

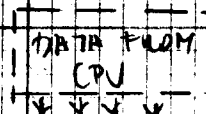
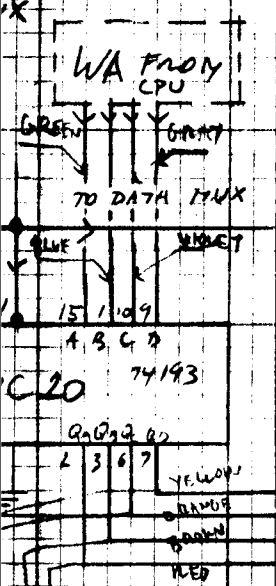

7475

SEL

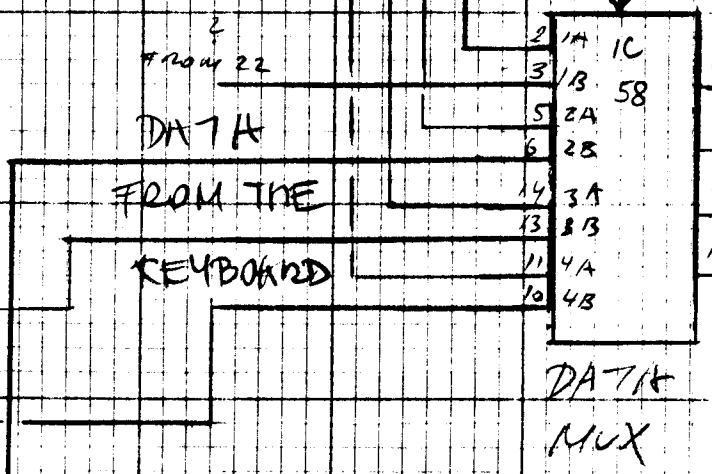

DATA MUX

7417

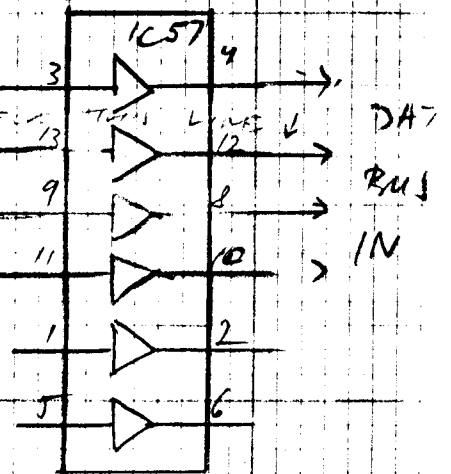

DATA BUS IN

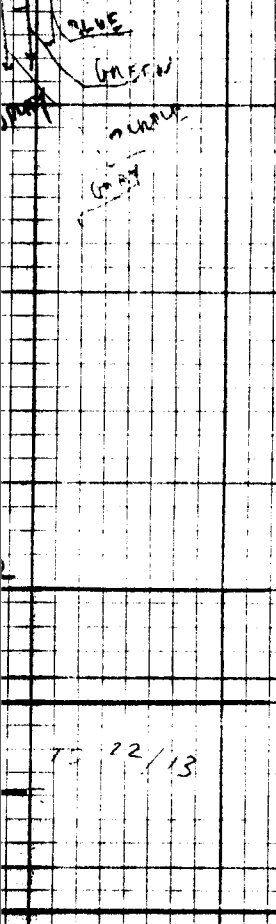

TO 22/13

CURSOR LOCATION AND DATA OUT LOGIC

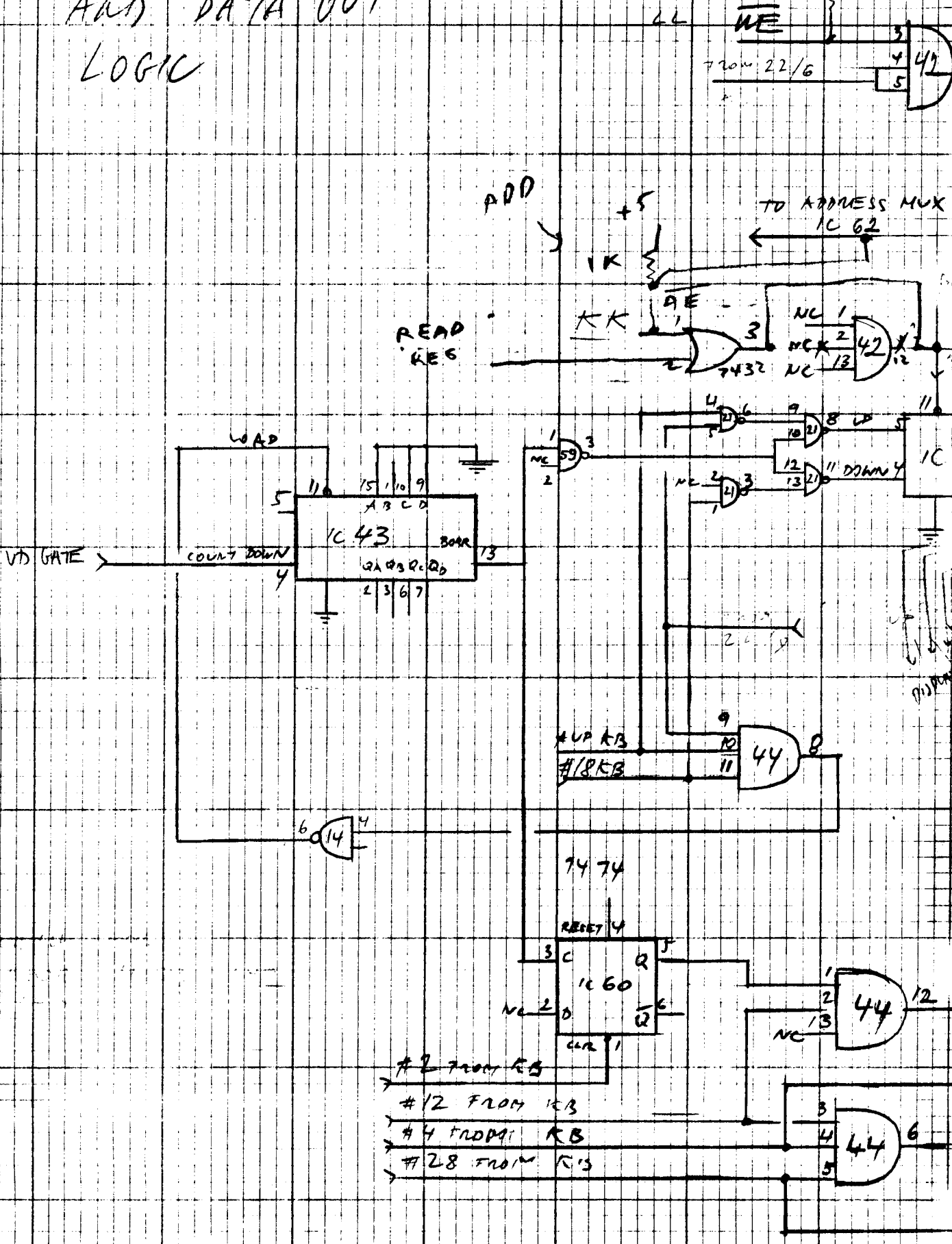

FROM MEMORY

DECADE COUNTERS (SCALER)

SCALER:

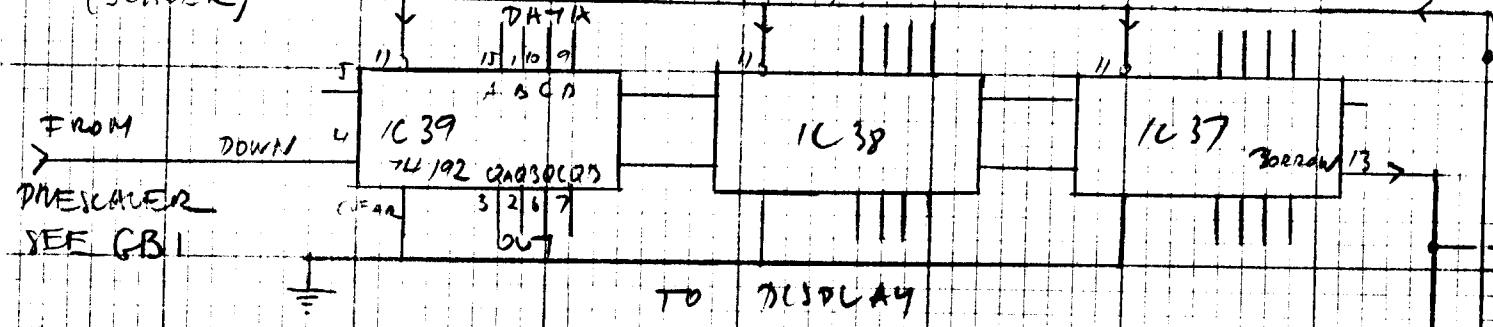

PRESCALER SEE GB1

NEXT SER RUN BUTTON

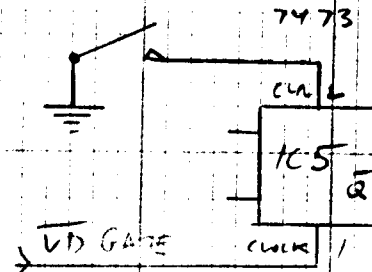

LOAD LOGIC:

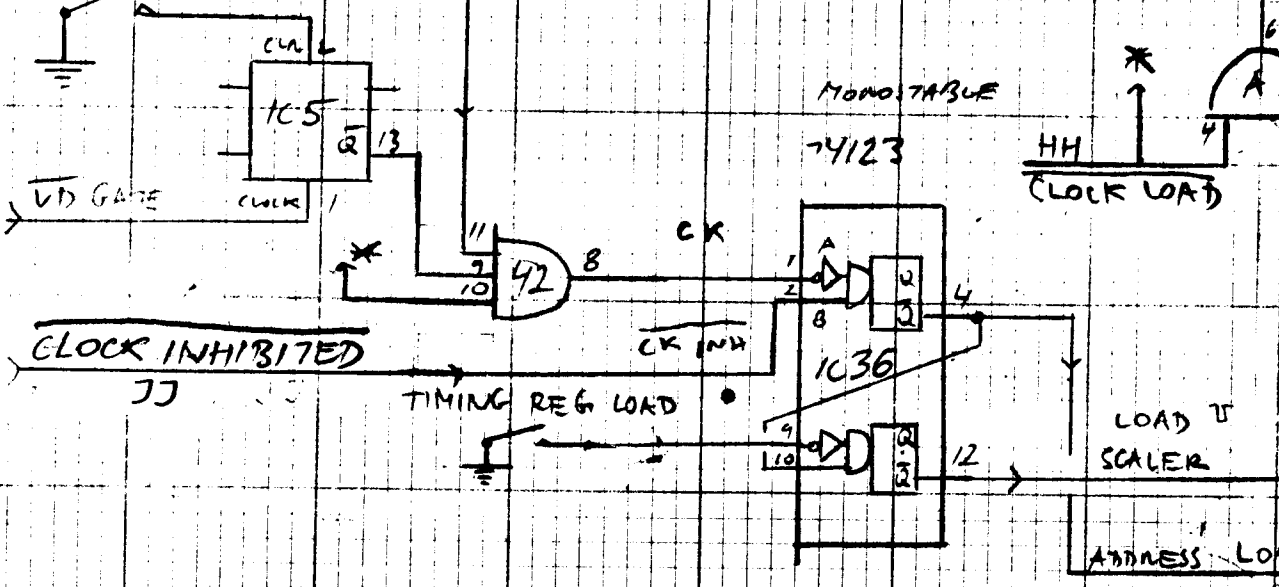

BINARY COUNTER (ADDRESS GENERATOR)

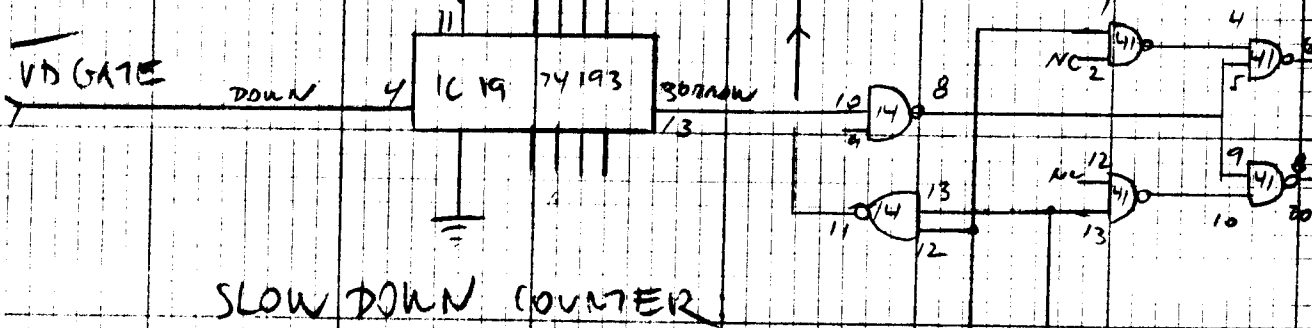

SLOW DOWN COUNTER

UP/DOWN SER PREVIEW

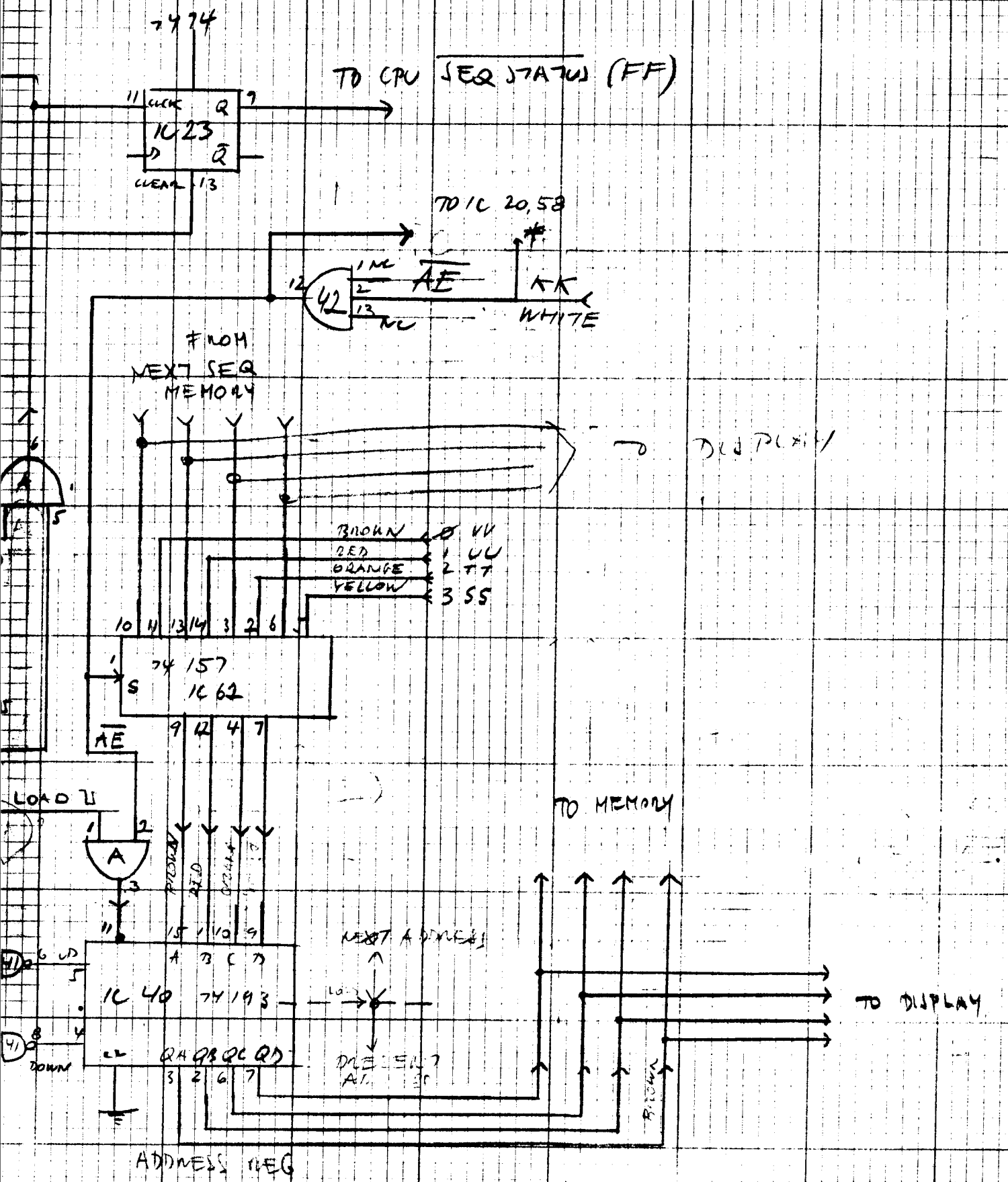

VIEW

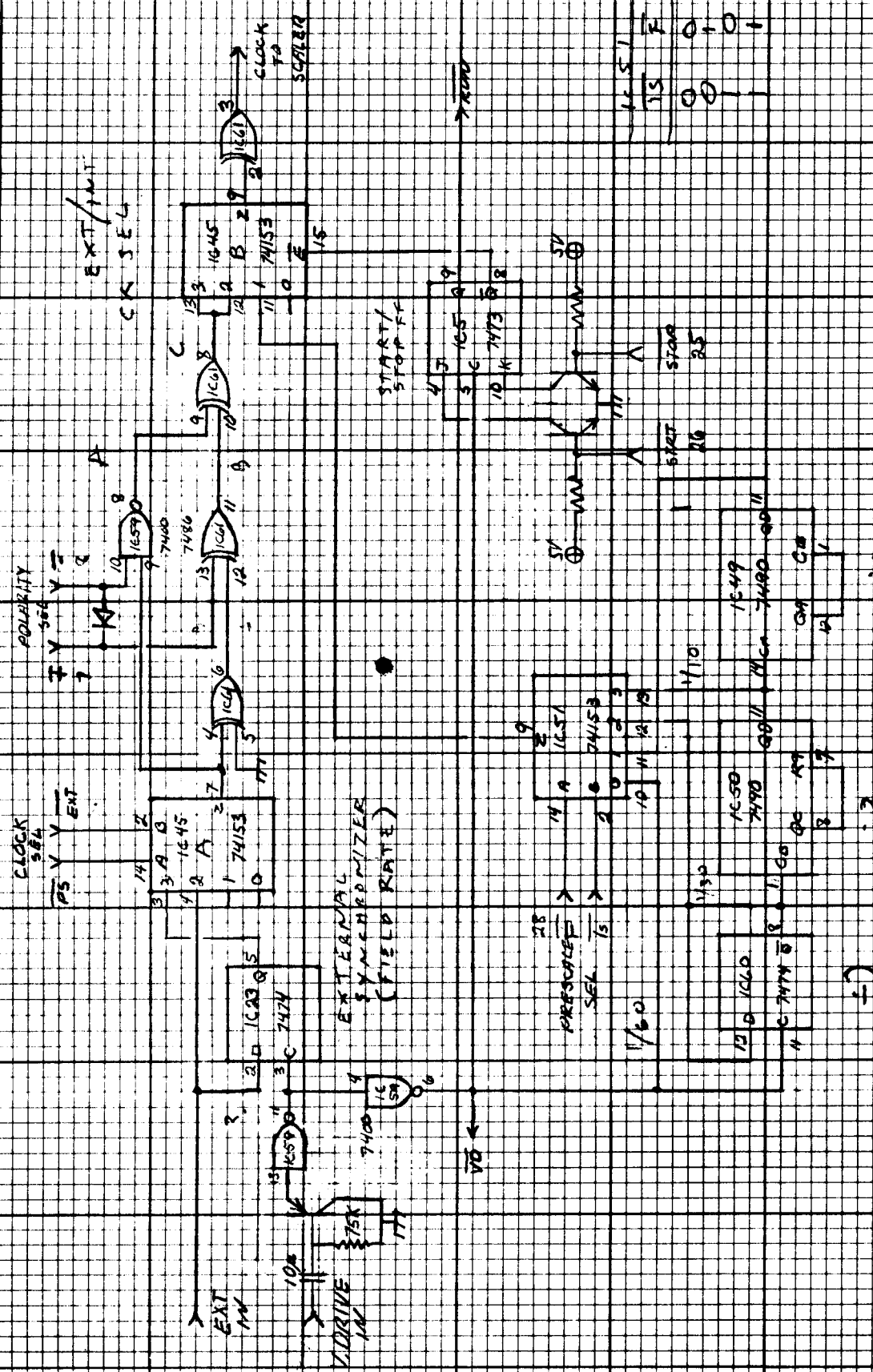

CLOCK AND PRESCALER

74155 / 1645	EXT	P5	A	B	H
0	0	0	0	0	0
0	0	0	0	1	0
0	0	0	1	0	0
0	0	0	1	1	0
0	1	0	0	0	0
0	1	0	0	1	0
0	1	0	1	0	0
0	1	0	1	1	0
0	1	1	0	0	0
0	1	1	0	1	0
0	1	1	1	0	0
0	1	1	1	1	0
1	0	0	0	0	0
1	0	0	0	1	0
1	0	0	1	0	0
1	0	0	1	1	0
1	0	1	0	0	0
1	0	1	0	1	0
1	0	1	1	0	0
1	0	1	1	1	0
1	1	0	0	0	0
1	1	0	0	1	0
1	1	0	1	0	0
1	1	0	1	1	0
1	1	1	0	0	0
1	1	1	0	1	0
1	1	1	1	0	0
1	1	1	1	1	0

1645	EXT	P5	A	B	H
0	0	0	0	0	0
0	0	0	0	1	0
0	0	0	1	0	0
0	0	0	1	1	0
0	1	0	0	0	0
0	1	0	0	1	0
0	1	0	1	0	0
0	1	0	1	1	0
0	1	1	0	0	0
0	1	1	0	1	0
0	1	1	1	0	0
0	1	1	1	1	0
1	0	0	0	0	0
1	0	0	0	1	0
1	0	0	1	0	0
1	0	0	1	1	0
1	0	1	0	0	0
1	0	1	0	1	0
1	0	1	1	0	0
1	0	1	1	1	0
1	1	0	0	0	0
1	1	0	0	1	0
1	1	0	1	0	0
1	1	0	1	1	0
1	1	1	0	0	0
1	1	1	0	1	0
1	1	1	1	0	0
1	1	1	1	1	0

1650	74153	74145	74153	74155	1645
0	0	0	0	0	0
0	0	0	0	1	0
0	0	0	1	0	0
0	0	0	1	1	0
0	1	0	0	0	0
0	1	0	0	1	0
0	1	0	1	0	0
0	1	0	1	1	0
0	1	1	0	0	0
0	1	1	0	1	0
0	1	1	1	0	0
0	1	1	1	1	0
1	0	0	0	0	0
1	0	0	0	1	0
1	0	0	1	0	0
1	0	0	1	1	0
1	0	1	0	0	0
1	0	1	0	1	0
1	0	1	1	0	0
1	0	1	1	1	0
1	1	0	0	0	0
1	1	0	0	1	0
1	1	0	1	0	0
1	1	0	1	1	0
1	1	1	0	0	0
1	1	1	0	1	0
1	1	1	1	0	0
1	1	1	1	1	0

1650	74153	74145	74153	74155	1645
0	0	0	0	0	0
0	0	0	0	1	0
0	0	0	1	0	0
0	0	0	1	1	0
0	1	0	0	0	0
0	1	0	0	1	0
0	1	0	1	0	0
0	1	0	1	1	0
0	1	1	0	0	0
0	1	1	0	1	0
0	1	1	1	0	0
0	1	1	1	1	0
1	0	0	0	0	0
1	0	0	0	1	0
1	0	0	1	0	0
1	0	0	1	1	0
1	0	1	0	0	0
1	0	1	0	1	0
1	0	1	1	0	0
1	0	1	1	1	0
1	1	0	0	0	0
1	1	0	0	1	0
1	1	0	1	0	0
1	1	0	1	1	0
1	1	1	0	0	0
1	1	1	0	1	0
1	1	1	1	0	0
1	1	1	1	1	0

DISPLAY ADDRESS

1
2
3
4

DISPLAY BOARD

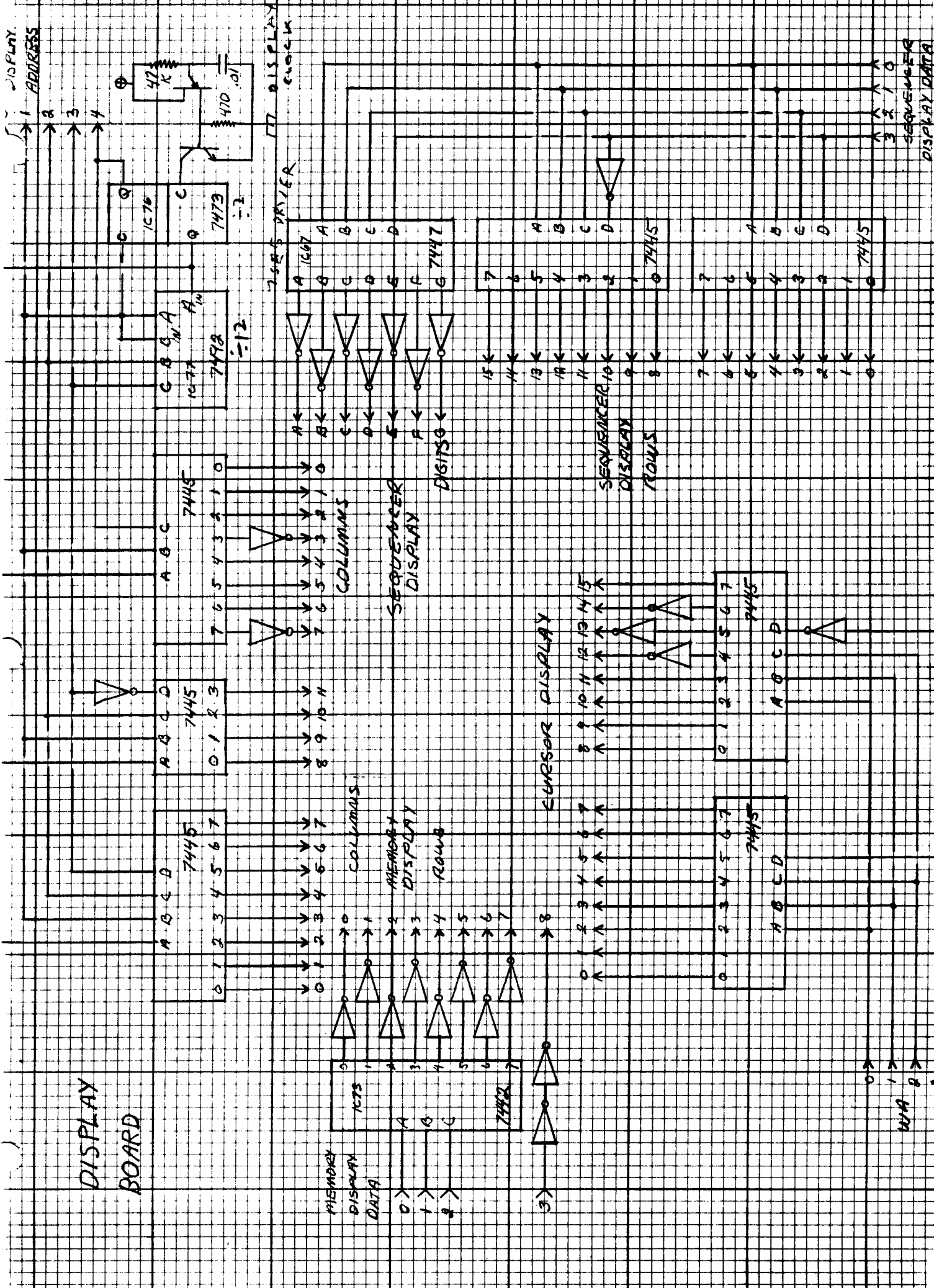

0
1
2
3

MEMORY DISPLAY DATA

0
1
2
3
4
5
6
7
8

ADDRESS

1
2
3
4

SEQUENCE DISPLAY

0
1
2
3
4
5
6
7
8
9

COLUMNS

0
1
2
3
4
5
6
7

ROWS

0
1
2
3
4
5
6
7

DRIVER

47K
470µF

7445

A
B
C
D

7446

A
B
C
D

7447

A
B
C
D

7448

A
B
C
D

7449

A
B
C
D

7490

A
B
C
D

7491

A
B
C
D

7492

A
B
C
D

7493

A
B
C
D

7494

A
B
C
D

7495

A
B
C
D

7496

A
B
C
D

7497

A
B
C
D

7498

A
B
C
D

7499

A
B
C
D

749A

A
B
C
D

749B

A
B
C
D

749C

A
B
C
D

749D

A
B
C
D

749E

A
B
C
D

749F

A
B
C
D

749G

A
B
C
D

749H

A
B
C
D

749I

A
B
C
D

749J

A
B
C
D

749K

A
B
C
D

749L

A
B
C
D

749M

A
B
C
D

749N

A
B
C
D

749O

A
B
C
D

749P

A
B
C
D

749Q

A
B
C
D

749R

A
B
C
D

749S

A
B
C
D

749T

A
B
C
D

749U

A
B
C
D

749V

A
B
C
D

749W

A
B
C
D

749X

A
B
C
D

749Y

A
B
C
D

749Z

A
B
C
D

PROGRAM MEMORY BITS

0 1 2 3 4 5 6 7 8 9 10 11 12 13 14 15 16 17 18 19 20 21 22 23 24 25 26 27 28 29 30 31 32 33 34 35 36 37 38 39 40 41 42 43 44 45 46 47 48 49 50

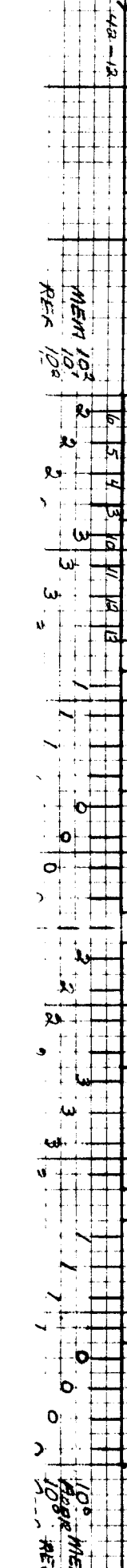
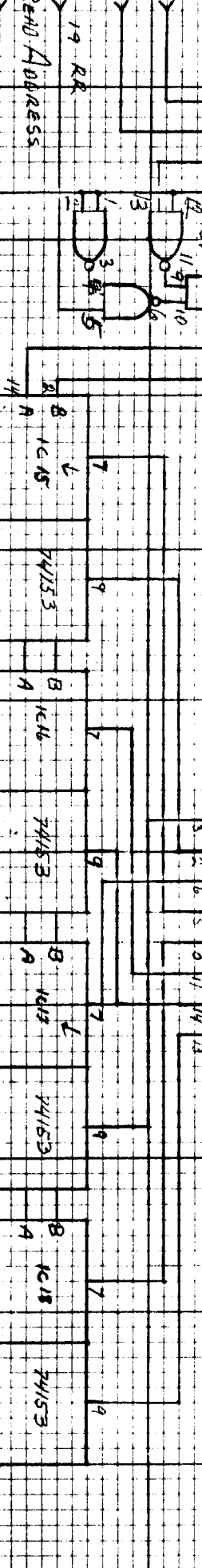
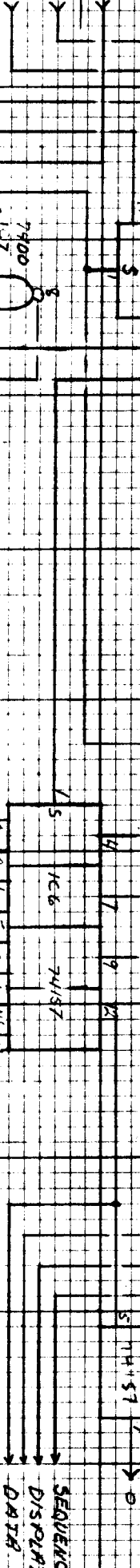
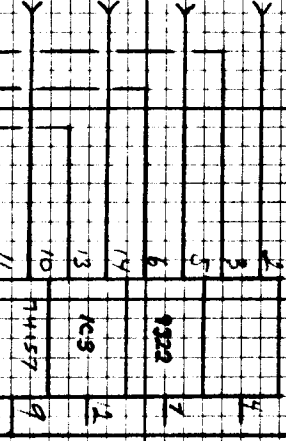
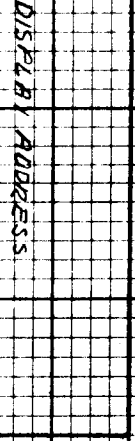
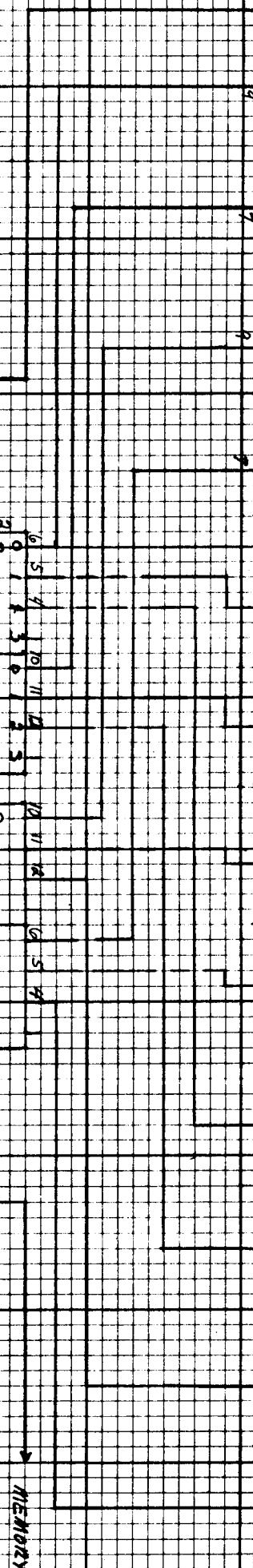

MEMORY DISPLAY DATA

MD

10 MEMA
10 MEMB

SEQUENCER
DISPLAY
DATA

MULTIPLIER
READ

DISPLAY ADDRESS

10 MEMA
10 MEMB

REMA ADDRESS

MEMA
MEMB

VIDEO

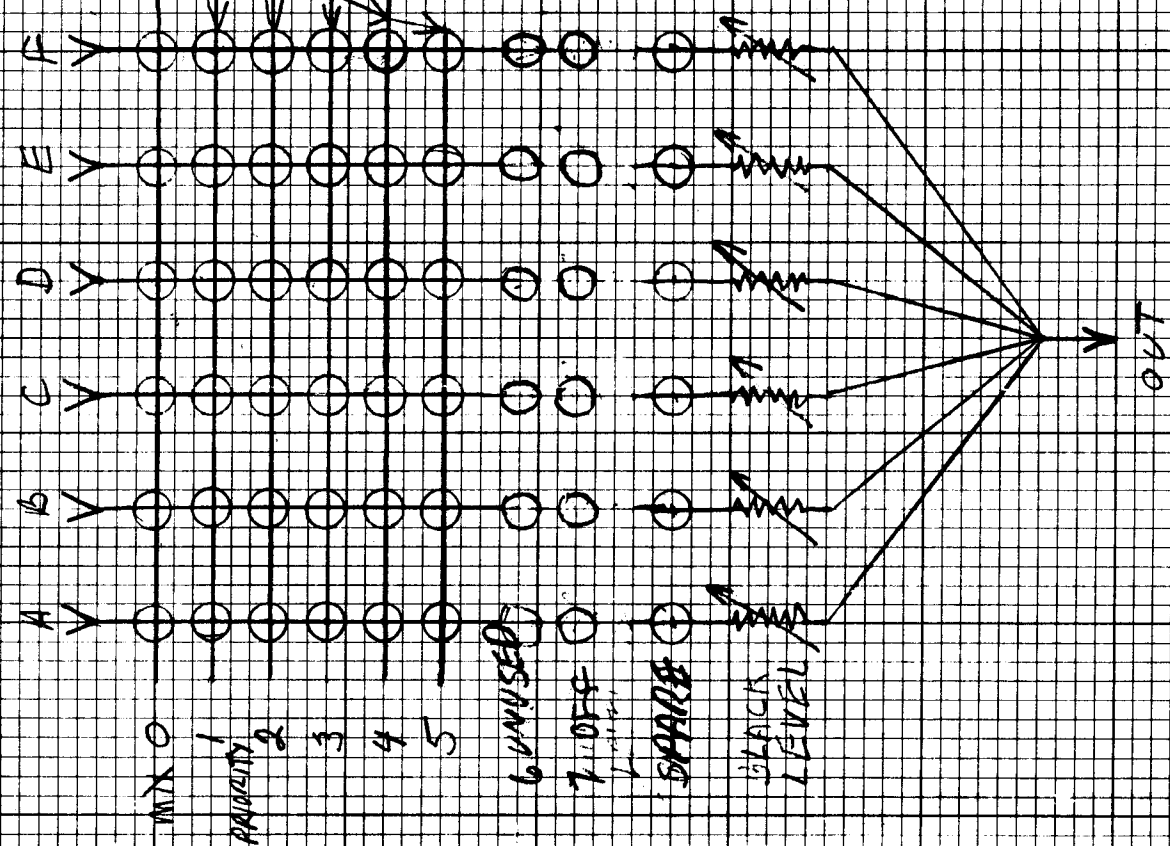

KEY

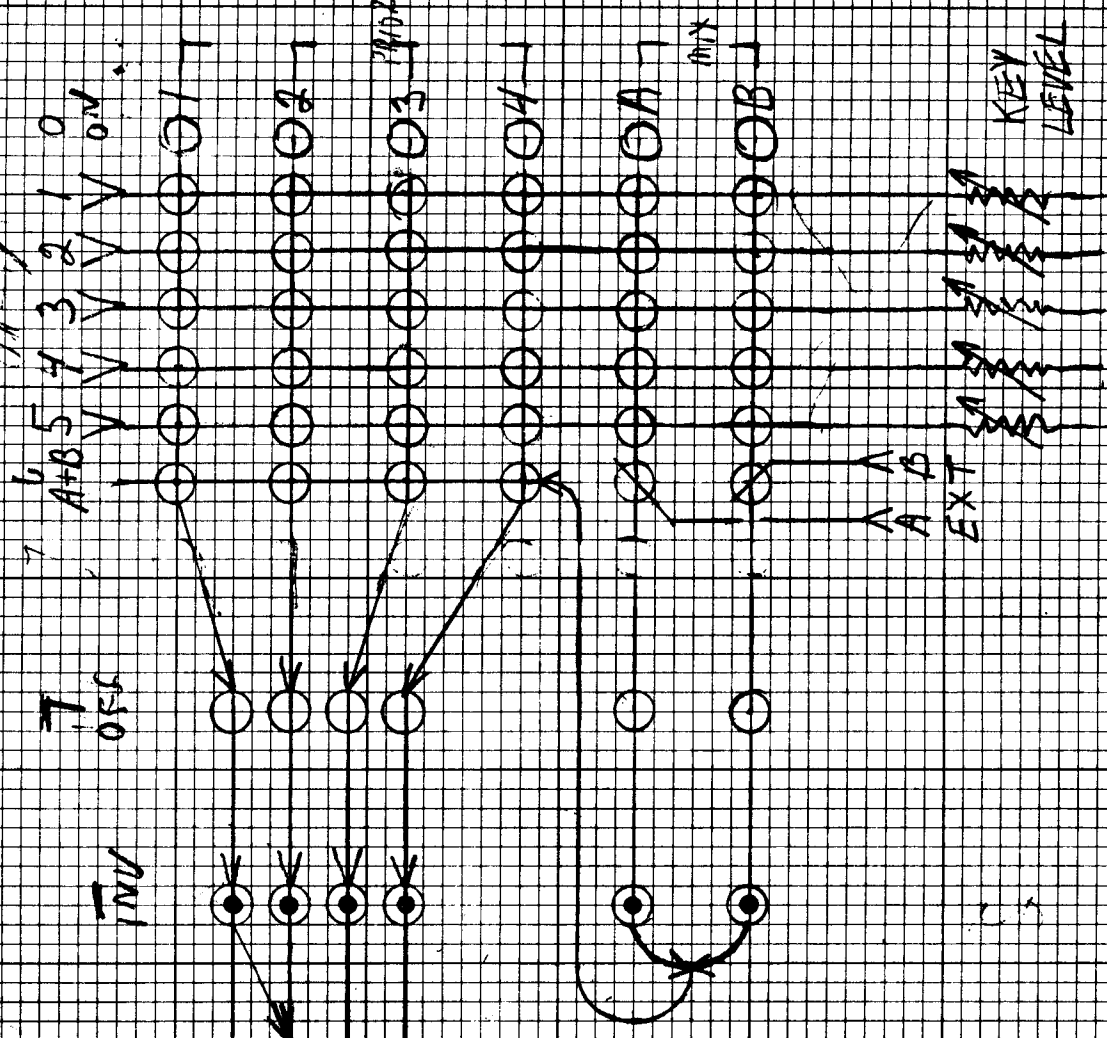

~~79~~

7908 ✓

79
19

79
60

79
63

79
81

79
12

79
51

79
55

79
54

79
59

79
25

79
52

79
60

79
53

79
42

79
18

79
08

79
68

79
28

79
27

79
26

79
23

79
22

79
21

79
20

79
17

79
14

79
12

79
10

79
11

79
14

79

~~79~~

~~79~~

79

Handwritten notes on graph paper, consisting of seven vertical rectangular boxes. Each box contains a vertical list of numbers and a larger number at the bottom. From left to right, the boxes contain: 1) 12, 14, 16, 18, 20, 22; 2) 13, 15, 17, 19, 21, 23; 3) 14, 16, 18, 20, 22, 24; 4) 15, 17, 19, 21, 23, 25; 5) 16, 18, 20, 22, 24, 26; 6) 17, 19, 21, 23, 25, 27; 7) 18, 20, 22, 24, 26, 28.

Handwritten notes on graph paper, consisting of thirteen vertical rectangular boxes. Each box contains a vertical list of numbers and a larger number at the bottom. From left to right, the boxes contain: 1) 19, 21, 23, 25, 27, 29; 2) 20, 22, 24, 26, 28, 30; 3) 21, 23, 25, 27, 29, 31; 4) 22, 24, 26, 28, 30, 32; 5) 23, 25, 27, 29, 31, 33; 6) 24, 26, 28, 30, 32, 34; 7) 25, 27, 29, 31, 33, 35; 8) 26, 28, 30, 32, 34, 36; 9) 27, 29, 31, 33, 35, 37; 10) 28, 30, 32, 34, 36, 38; 11) 29, 31, 33, 35, 37, 39; 12) 30, 32, 34, 36, 38, 40; 13) 31, 33, 35, 37, 39, 41.

Handwritten notes on graph paper, consisting of seven vertical rectangular boxes. Each box contains a vertical list of numbers and a larger number at the bottom. From left to right, the boxes contain: 1) 32, 34, 36, 38, 40, 42; 2) 33, 35, 37, 39, 41, 43; 3) 34, 36, 38, 40, 42, 44; 4) 35, 37, 39, 41, 43, 45; 5) 36, 38, 40, 42, 44, 46; 6) 37, 39, 41, 43, 45, 47; 7) 38, 40, 42, 44, 46, 48.

Handwritten notes on graph paper, consisting of five horizontal rectangular boxes. Each box contains a horizontal list of numbers and a larger number at the right end. From left to right, the boxes contain: 1) 42, 44, 46, 48, 50, 52; 2) 43, 45, 47, 49, 51, 53; 3) 44, 46, 48, 50, 52, 54; 4) 45, 47, 49, 51, 53, 55; 5) 46, 48, 50, 52, 54, 56.

VIDEO
BLOCK
MULTIPLIER

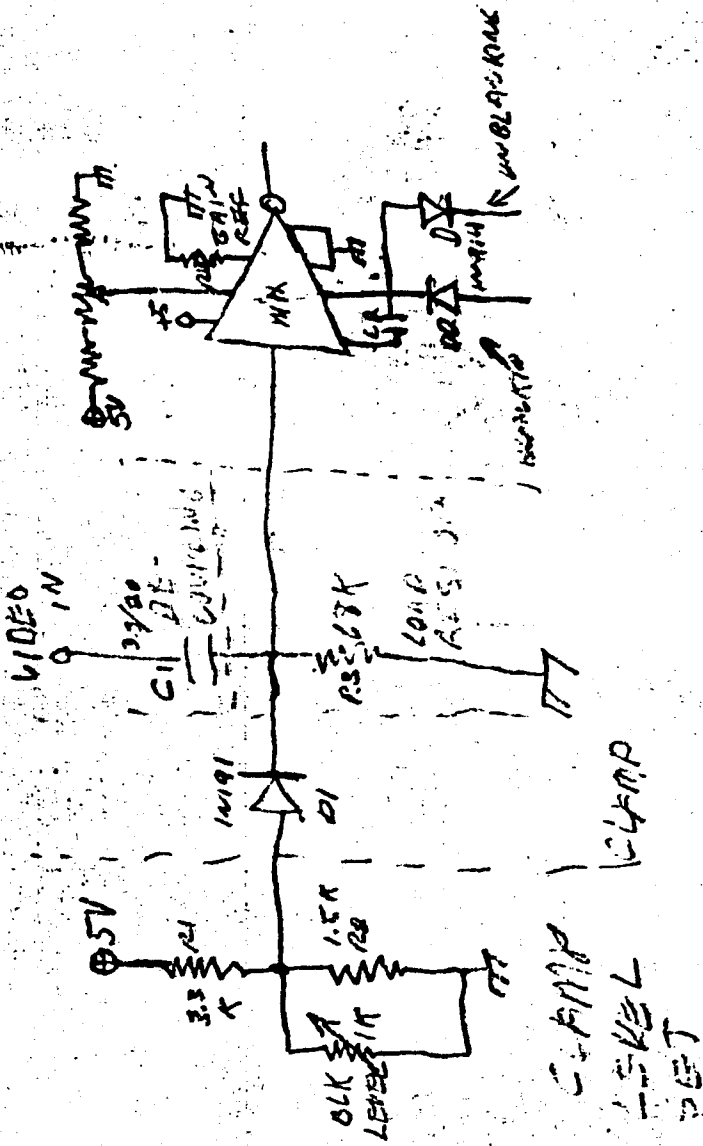

Cross Section
10 Squares to the Inch

VISION BOX LINE R 2470:10

MULTI-ANGLE

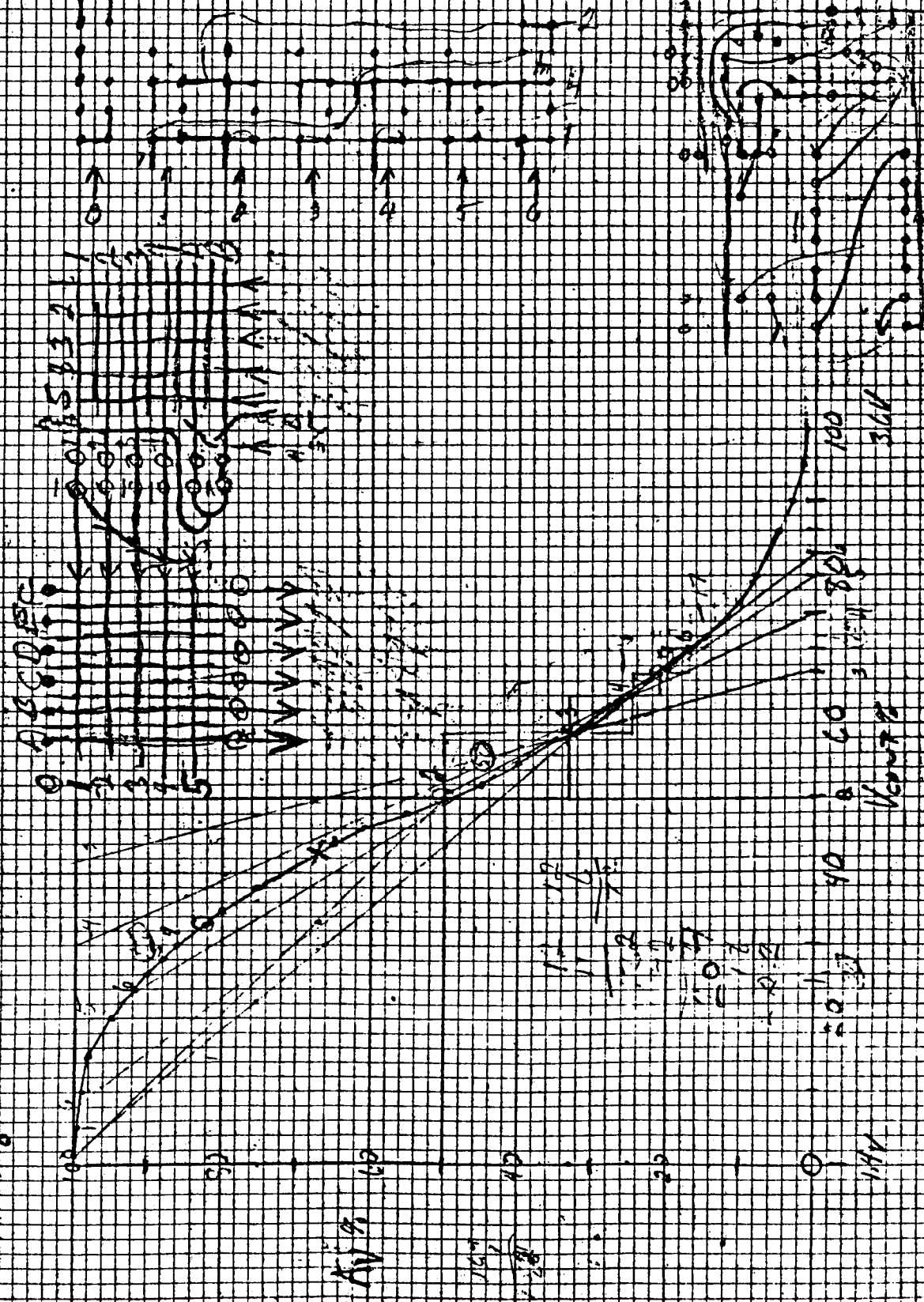

COMPLETE VIDEO BLOCK

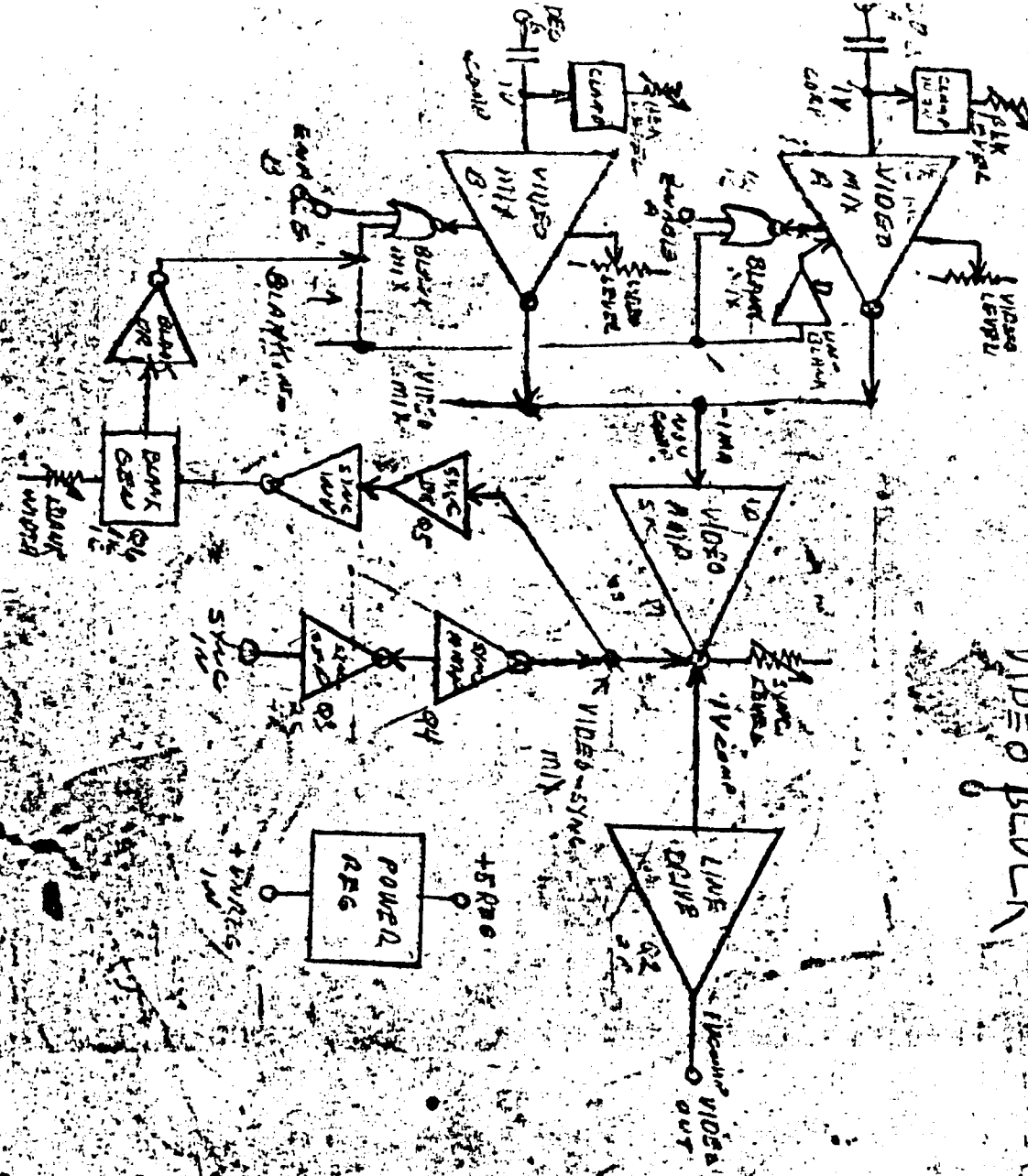

- CLAMP
- SYNC STRIP
- VIDEO LEVEL CONTROL
- VIDEO MIX
- LINE DRIVE
- SYNC ADDITION
- LINE DRIVE BLANKING
- VIDEO-SYNC
- VIDEO-A

MULTI-LEVEL
MIXER
Brown

MULTI-STEP FORWARD
GENERATOR

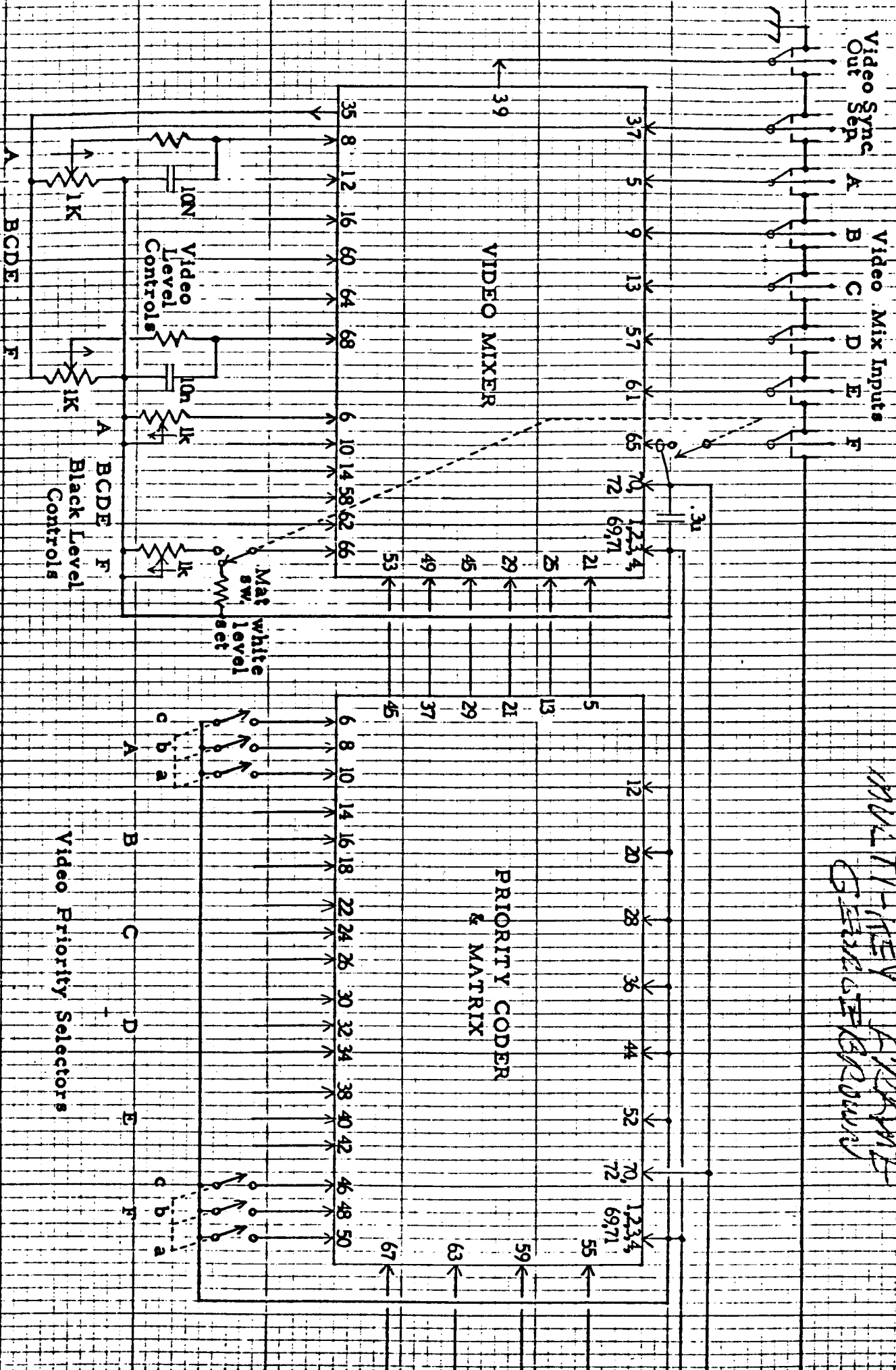

Video Sync
Out Sep

Video Mix Inputs
A B C D E F

VIDEO MIXER

PRIORITY CODER
& MATRIX

Video Priority Selectors

Ext Inputs
A
B

Power Supply/+

Video Key Inputs
1
2
3
4
5

KEY MIXER & MATRIX

KEYER

Priority & Mix Key Selectors

Key Level Controls

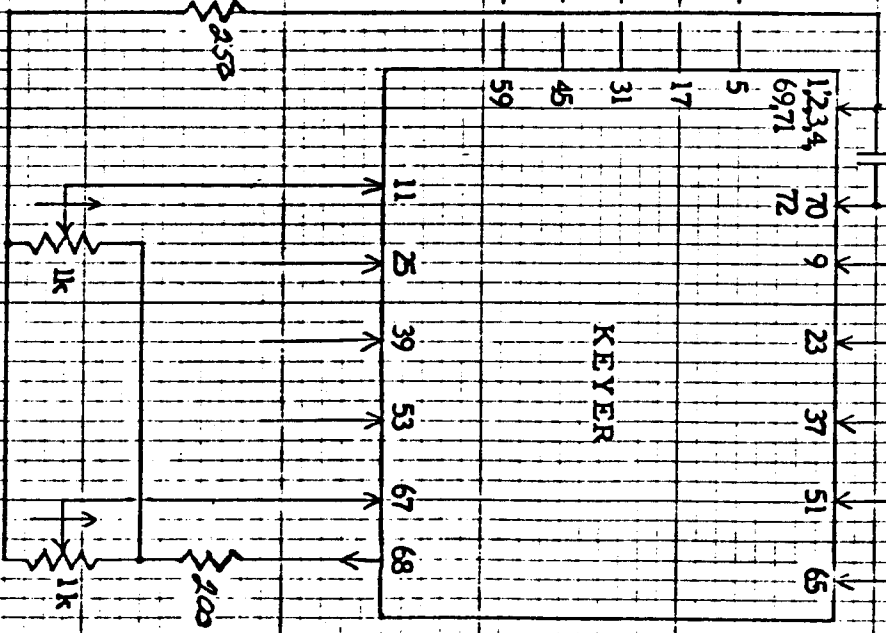
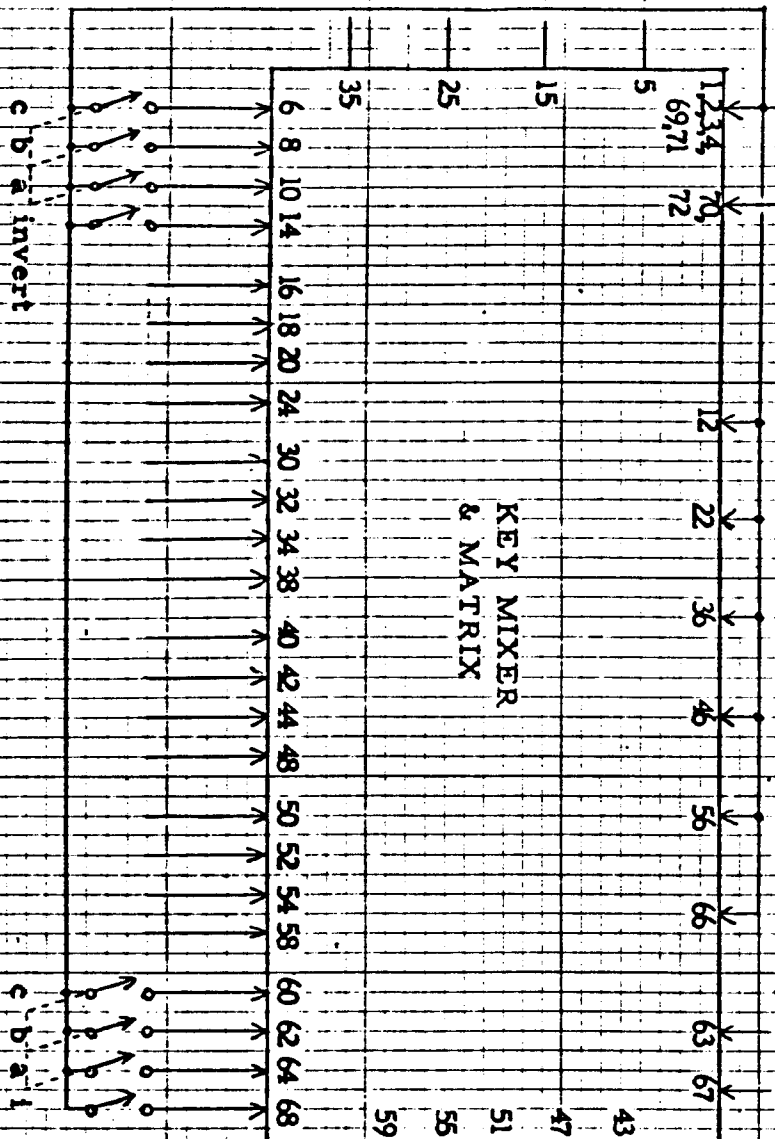

MULTI-REPLY FRAME
BRASS BRACK

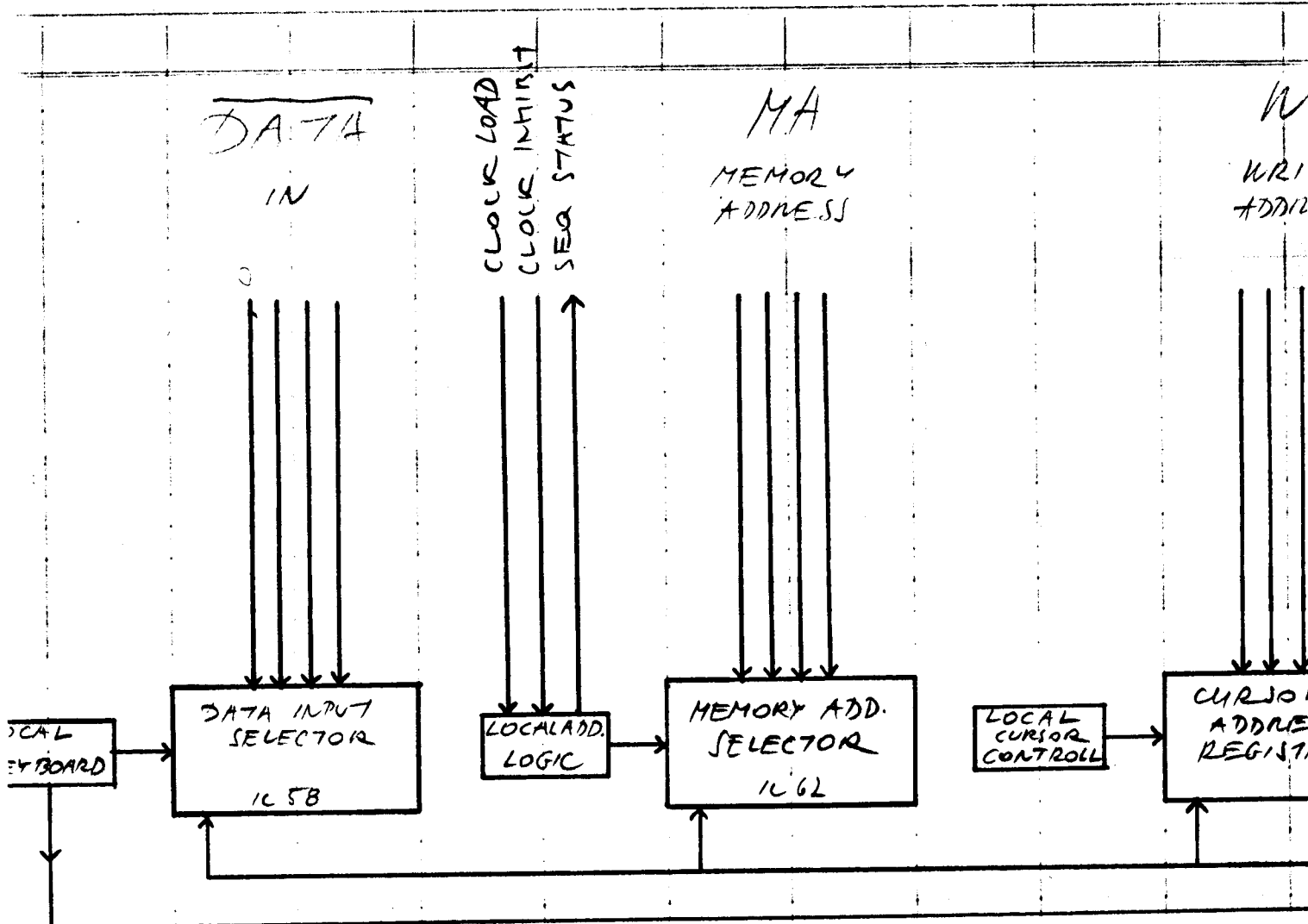

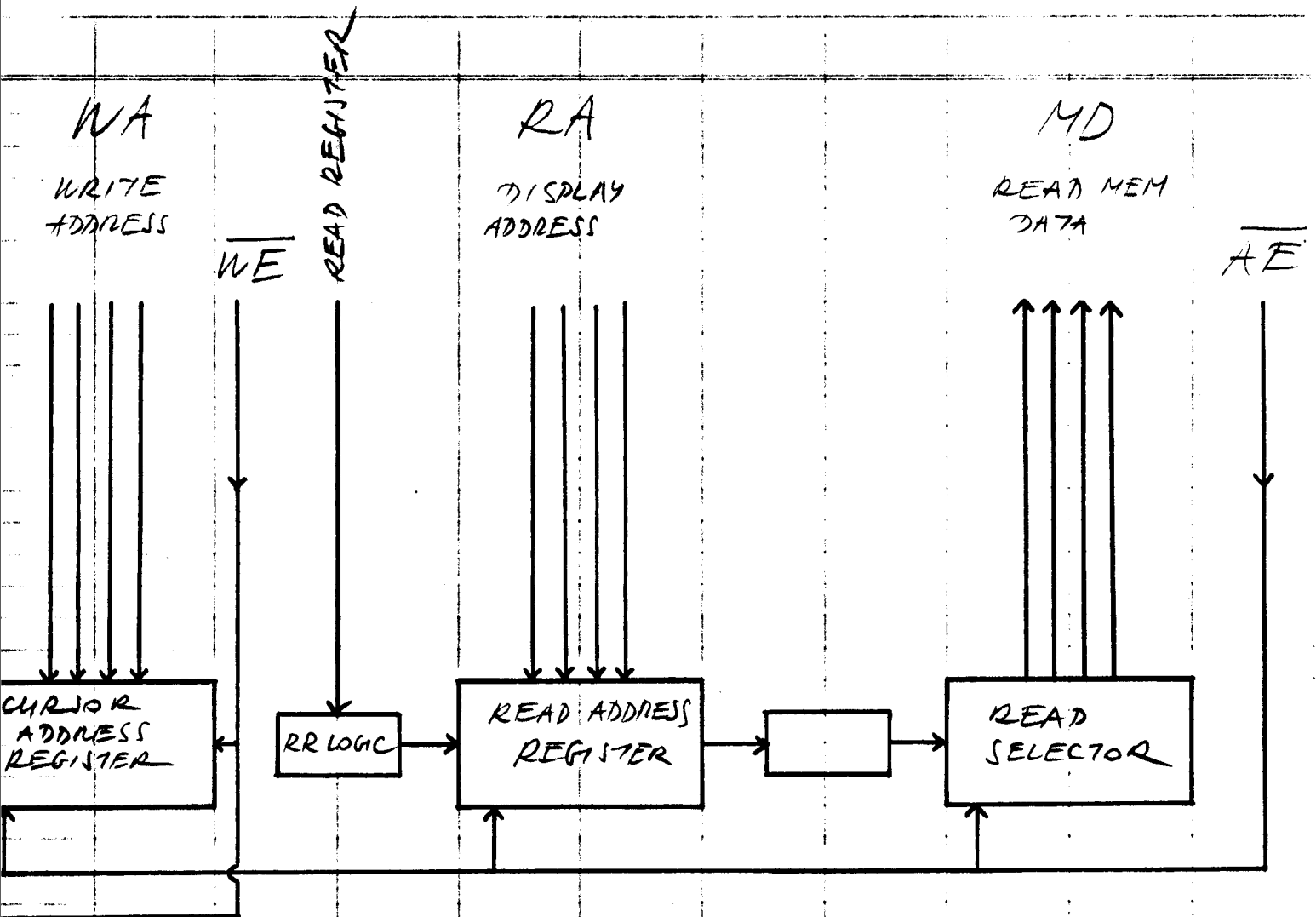

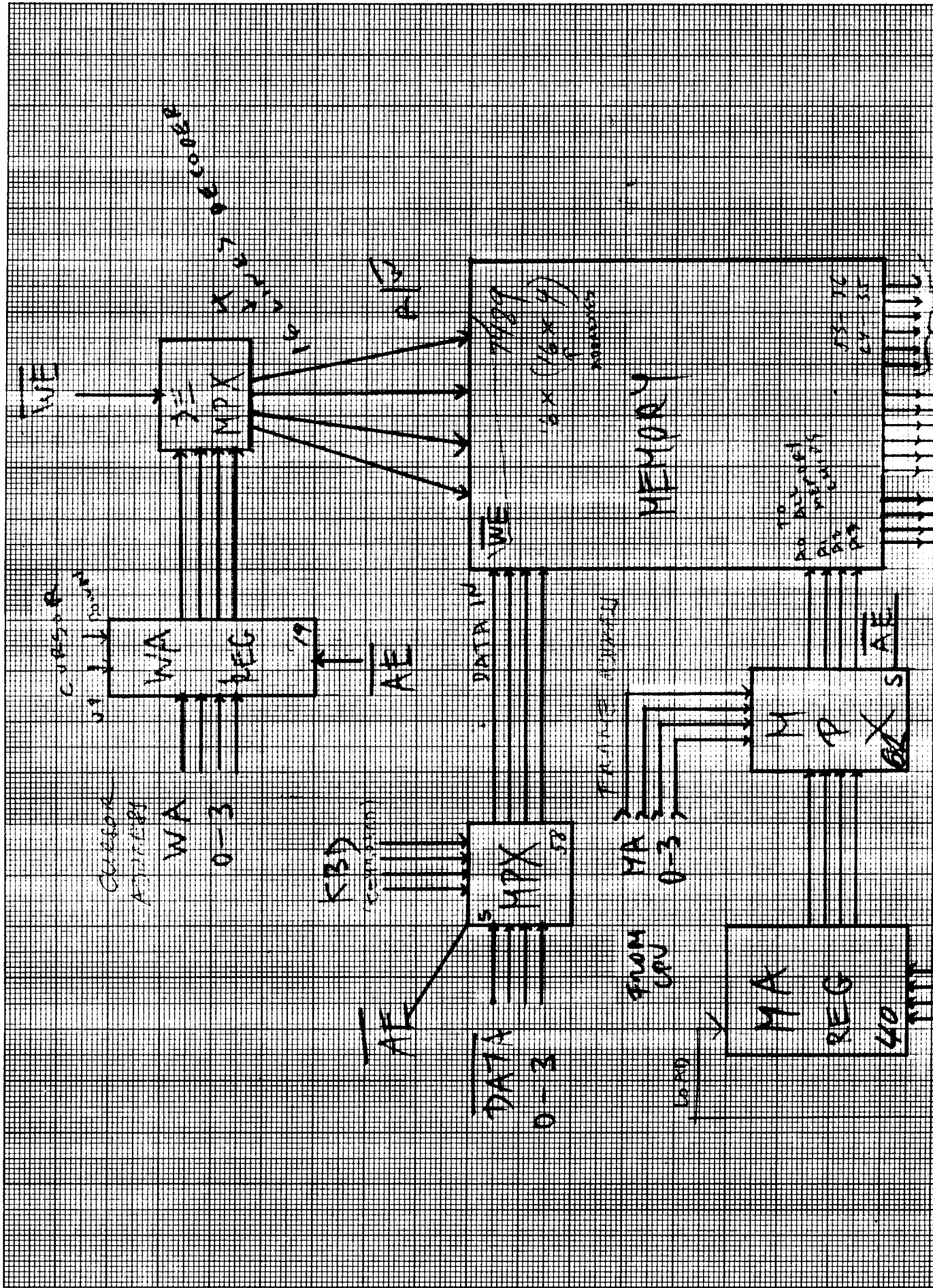

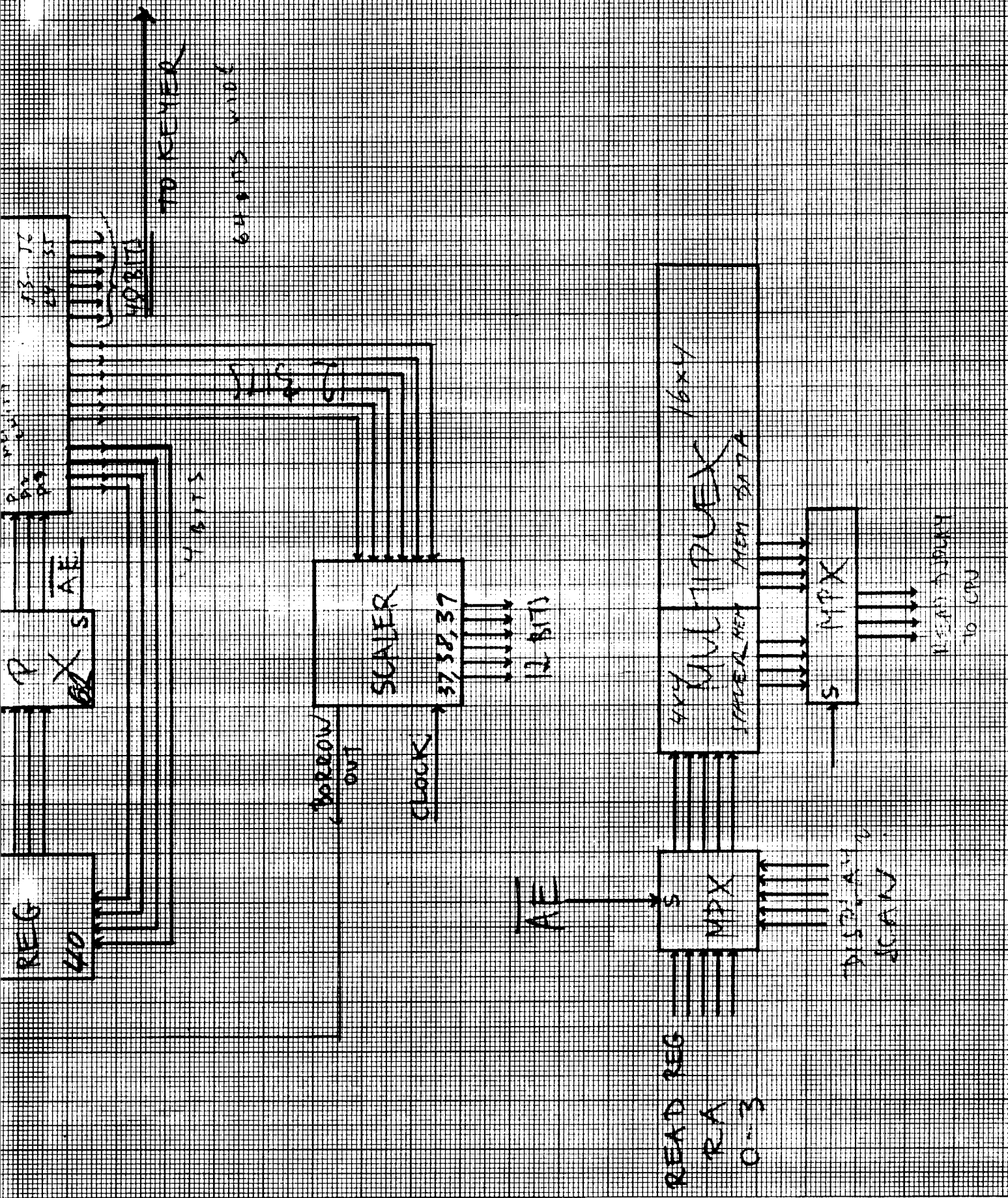

581707

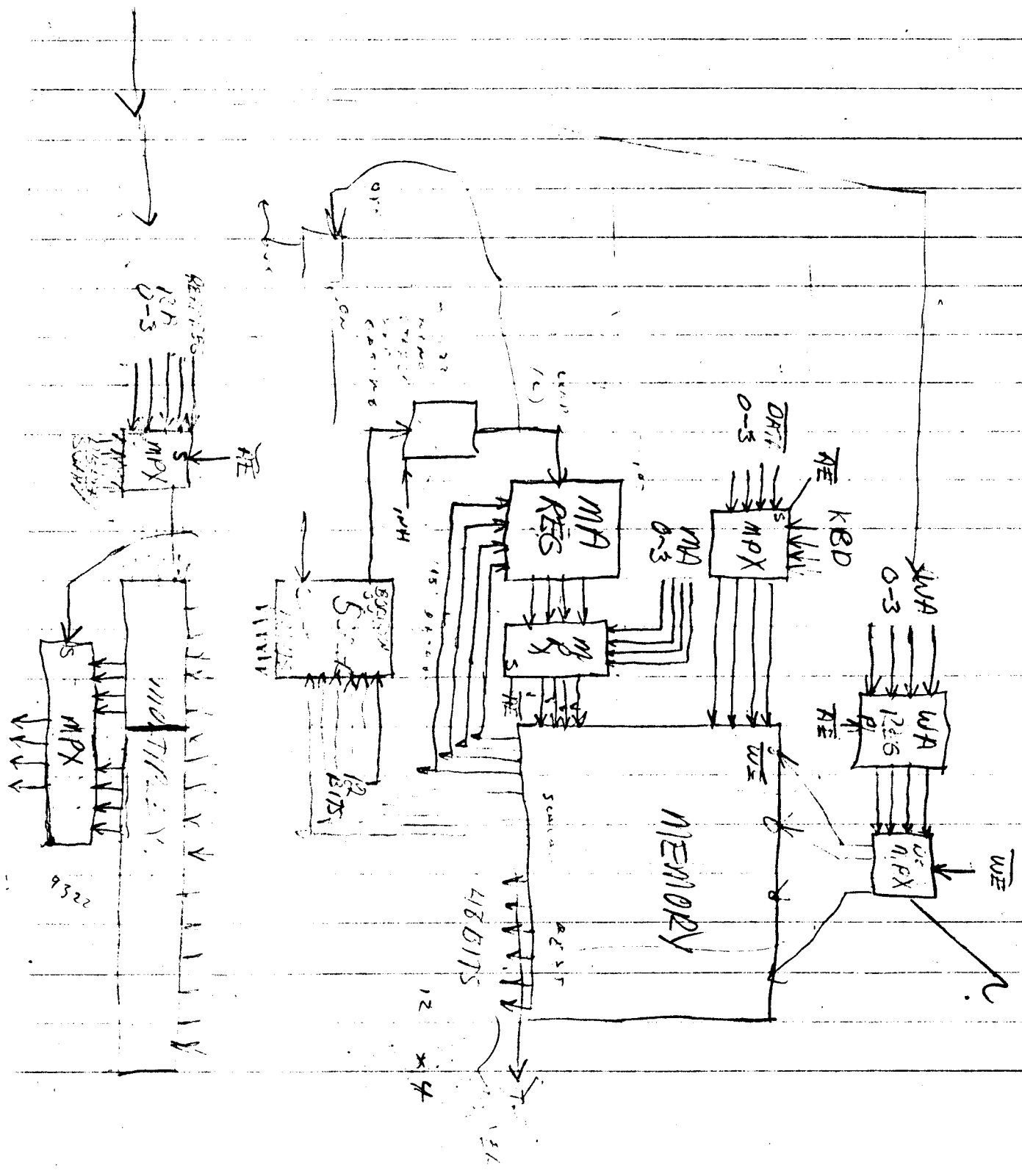

GEORGE BROWN:

VIDEO SEQUENCER

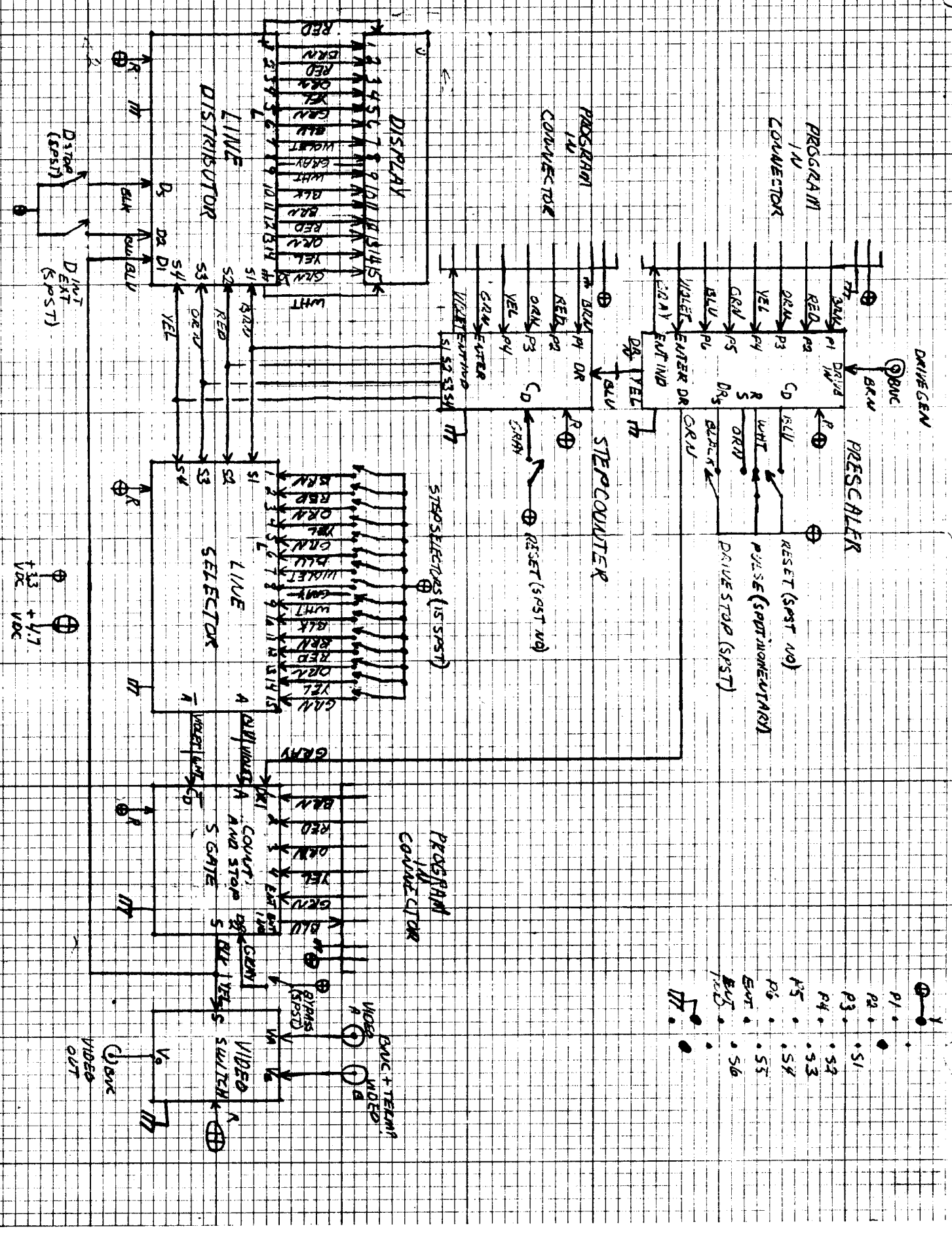

- P1 •
- P2 •
- P3 •
- P4 •
- P5 •
- P6 •
- ENT •
- ENT TOC •
- S1 •
- S2 •
- S3 •
- S4 •
- S5 •
- S6 •

DRIVE GEN

PRESCALER

STEP COUNTER

DISPLAY

LINE DISTRIBUTOR

LINE SELECTOR

STEP SELECTOR (15 SPST)

PROGRAM IN CONNECTOR

BUC + TERMIN VIDEO

DISTO (SPST)

DI EXT (SPST)

+1.3V

+4.7V

+5V

VIDEO IN

VIDEO OUT

VIDEO SWITCH

VIDEO

VIDEO

VIDEO

VIDEO

VIDEO

VIDEO

VIDEO

VIDEO

VIDEO

VIDEO

VIDEO

VIDEO

VIDEO

VIDEO

VIDEO

VIDEO

VIDEO

VIDEO

VIDEO

VIDEO

VIDEO

VIDEO

VIDEO

VIDEO

VIDEO

VIDEO

VIDEO

VIDEO

VIDEO

VIDEO

VIDEO

VIDEO

VIDEO

VIDEO

VIDEO

VIDEO

VIDEO

VIDEO

VIDEO

VIDEO

VIDEO

PRE SCALER CONTROLS

DRIVE STOP STOPS EXT DRIVE INPUT)

PULSE MANUALLY PULSES PRESCALER
 ALSO MOMENTARY DRIVE STOP

RESET RESETS COUNTER TO 0
 ALSO PULSES OUTPUT ~~OR~~
 DOES NOT ALLOW PROGRAM ENTRY

STEP COUNTER

RESET RESETS COUNTER TO 0
 ALLOWS PROGRAM ENTRY

LINE SELECTOR

STEP SELECTOR SWITCHES
SELECT CHANNEL A OR B FOR
EACH STEP OF SEQUENCE.

COUNT AND STOP S GATE

BY PASS REMOVES S GATE

LINE DISTRIBUTOR

D INT SELECTS EXTERNAL SIGNAL
EXT OR ALL OUTPUTS 1

D STOP ALL OUTPUTS 0

INPUTS
78

3432

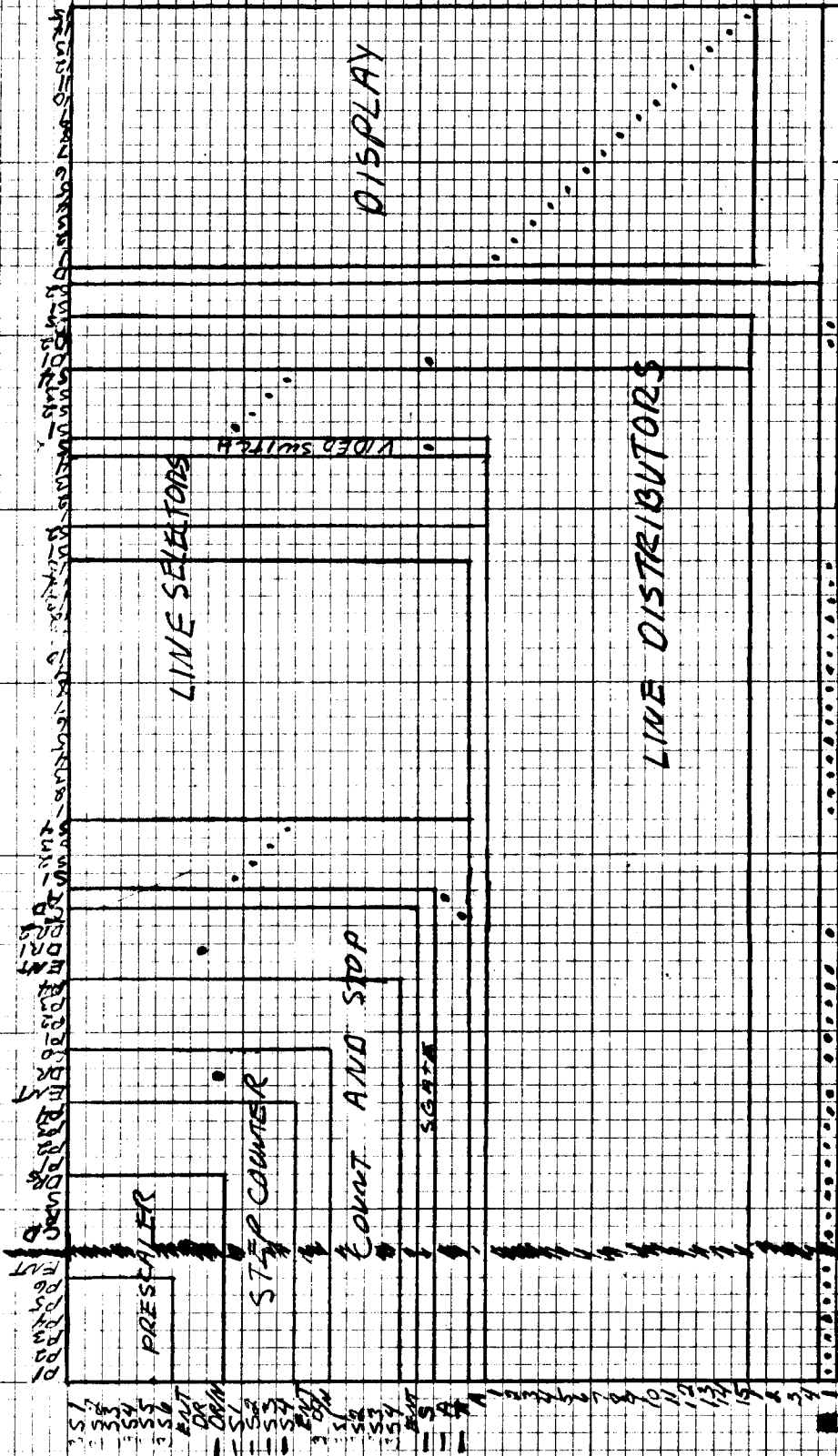

OUTPUTS
44

	A.	B.	C.	D.	E.	F.
A	A. 01. 1	A. 01. 1	A. 01. 1	A. 01. 1	A. 01. 1	A. 01. 1
B	Q2	Q2	S2	S2	Q2	Q2
C	Q3	Q3	S3	S3	Q3	Q3
D	Q4	Q4	S4	S4	Q4	Q4
E	Q5	Q5	S5	S5	Q5	Q5
F	Q6	Q6	S6	S6	Q6	Q6
H	DRIVE	DRIVE	D1	D1	DRIVE	DRIVE
J	DR2	DR2	D2	D2	DR2	DR2
K	DR3	DR3	D3	D3	DR3	DR3
L	DR4	DR4	D4	D4	DR4	DR4
M	DR5	DR5	D5	D5	DR5	DR5
N	DR6	DR6	D6	D6	DR6	DR6
P	DR7	DR7	D7	D7	DR7	DR7
R	DR8	DR8	D8	D8	DR8	DR8
S	DR9	DR9	D9	D9	DR9	DR9
T	DR10	DR10	D10	D10	DR10	DR10
U	DR11	DR11	D11	D11	DR11	DR11
V	DR12	DR12	D12	D12	DR12	DR12
W	DR13	DR13	D13	D13	DR13	DR13
X	DR14	DR14	D14	D14	DR14	DR14
Y	DR15	DR15	D15	D15	DR15	DR15
Z	DR16	DR16	D16	D16	DR16	DR16
	DR17	DR17	D17	D17	DR17	DR17
	DR18	DR18	D18	D18	DR18	DR18
	DR19	DR19	D19	D19	DR19	DR19
	DR20	DR20	D20	D20	DR20	DR20
	DR21	DR21	D21	D21	DR21	DR21
	DR22	DR22	D22	D22	DR22	DR22

A B C D E F

STEP COUNT

GEORGE BROWN SEQUENCER

OPERATIONS.

PROGRAMMER MODULE "L"

FUNCTION SELECTOR (3-POSITIONS)

POS 1 :

SEQUENCE SPEED
SELECTED NUMBER ~~AND~~ DETERMINES
POINT BY POINT SCAN TIME (1 TO 32 FIE)

POS 2 SEQUENCE LENGTH

16 - (0 to 35 POINTS)

POS 3 FIELD GROUP WINDOW

INSERTS AT THE POINT LOCATION
(SWITCH) SELECTED AMOUNT OF TRAMES

(LIGHT DISPLAY WITH SWITCH DOWN
INDICATES SWITCH OF STATE THE LENGTH
OF THE WINDOW. SWITCH UP
SHOWS THE WHOLE SCAN

STEP COUNT MODULE:

SWITCH UP IS NORMAL

SWITCH DOWN ACTIVATE THE BUTTON

TO SCAN THE SEQ ONES AND ZERO IT
AGAIN. DEPRESSED BUTTON ACTS AS SWITCH

UP

PROGRAMMABLE
4-63 SCALER

A-B SEQUENCER

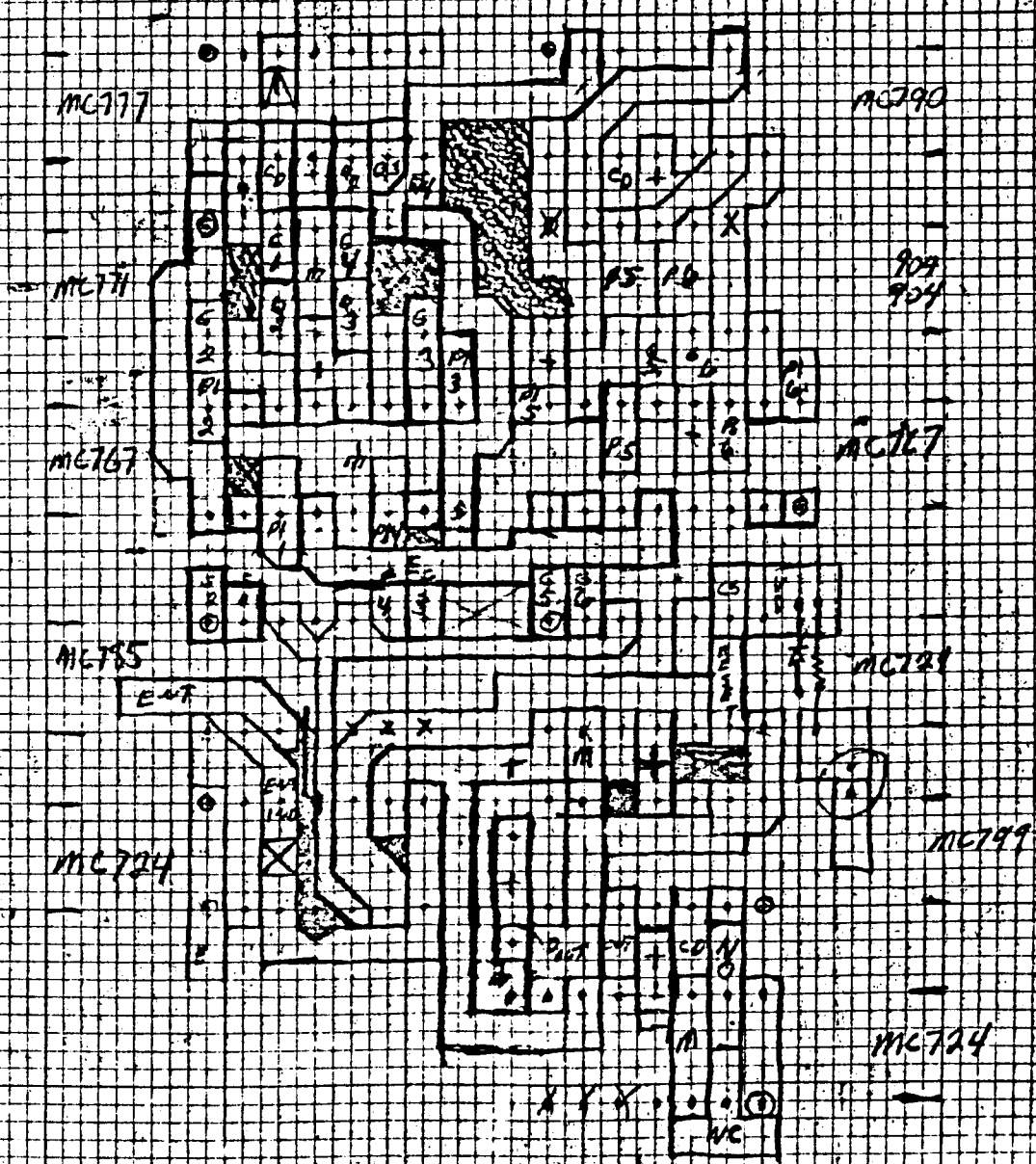

10 Squares to the inch

16 23 0 10

WASHER LINE

A-B SEQUENCE

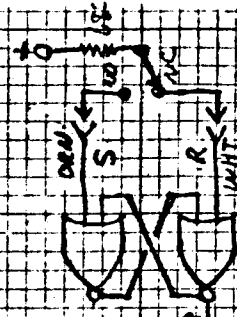
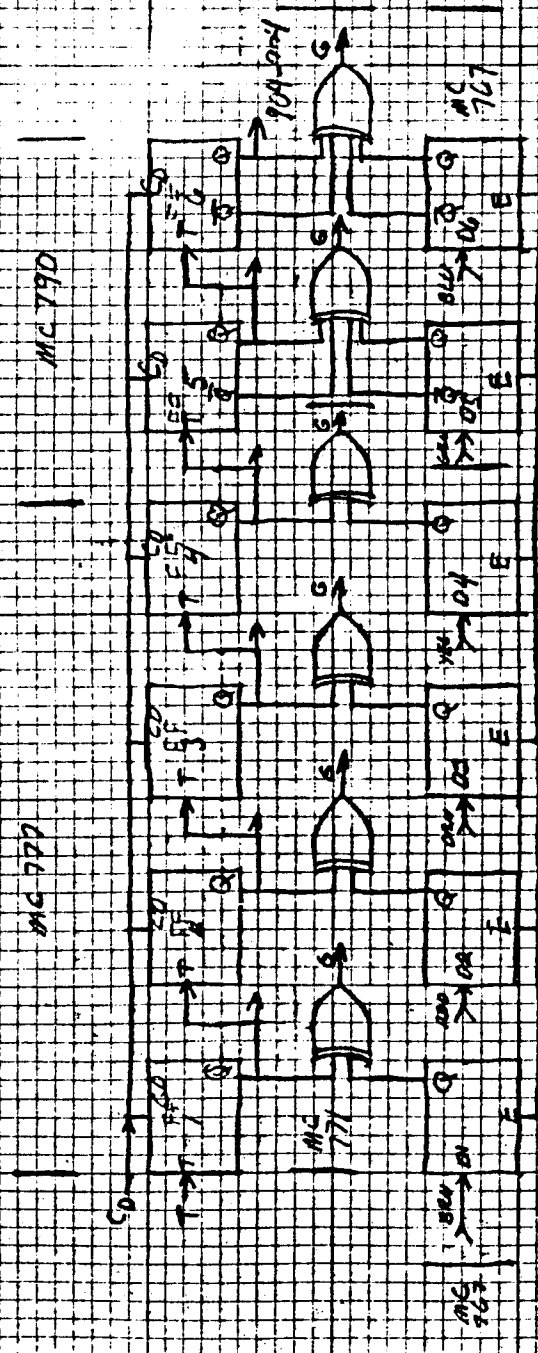

PROGRAMMABLE 1-63 SCALER

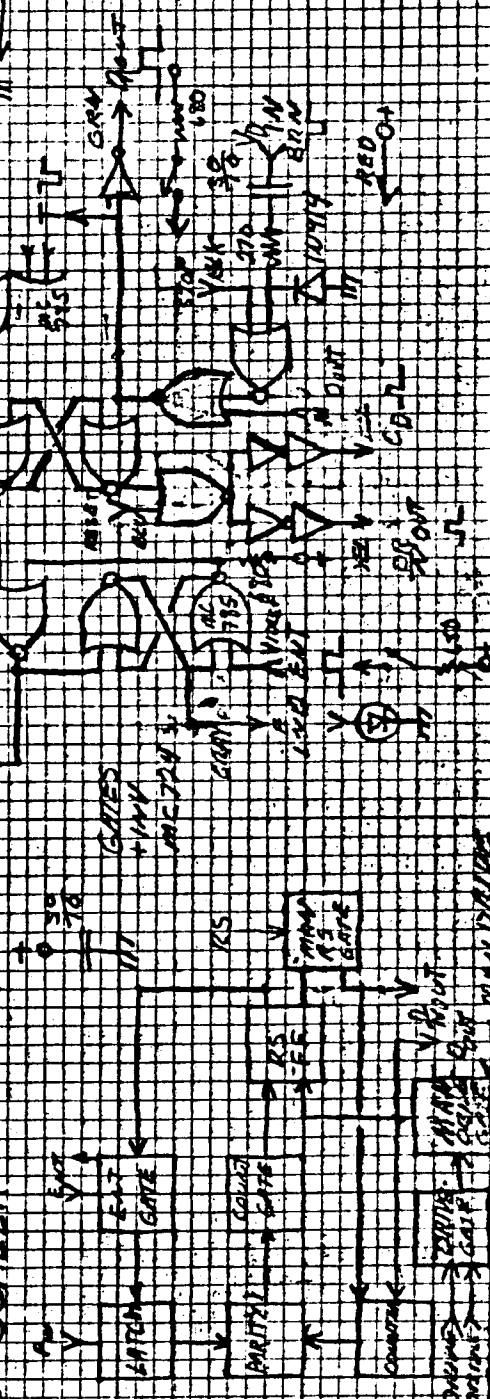

1-15
COUNT

799
777
767

799
777
767

799
777
767

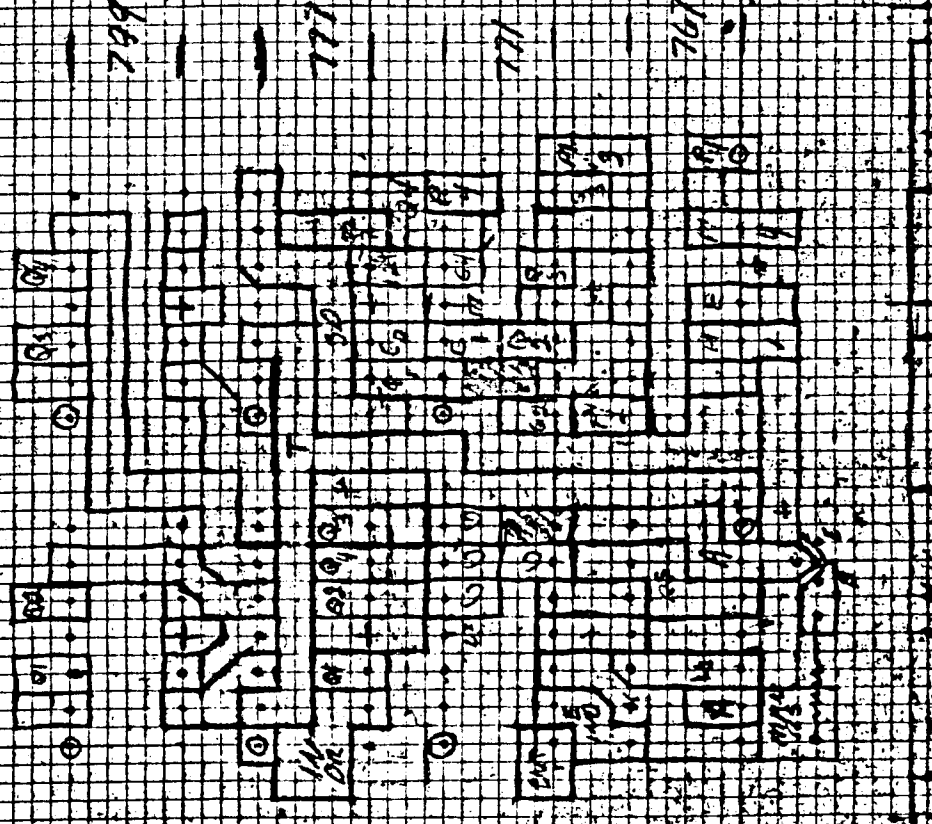

799
777
767

799
777
767

799
777
767

799
777
767

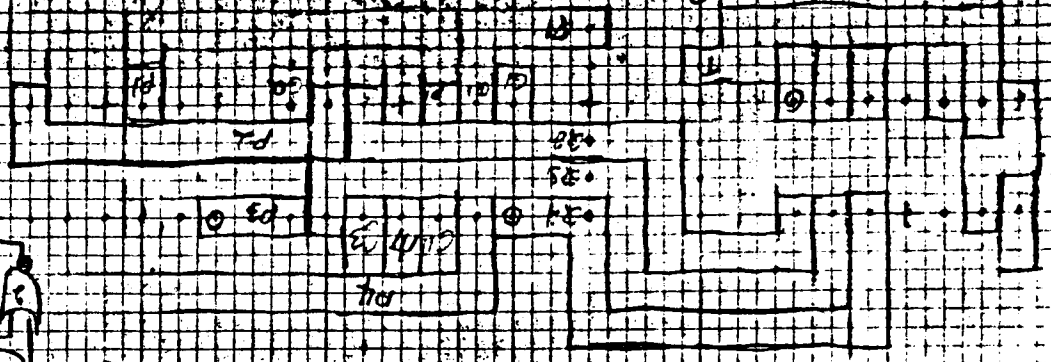
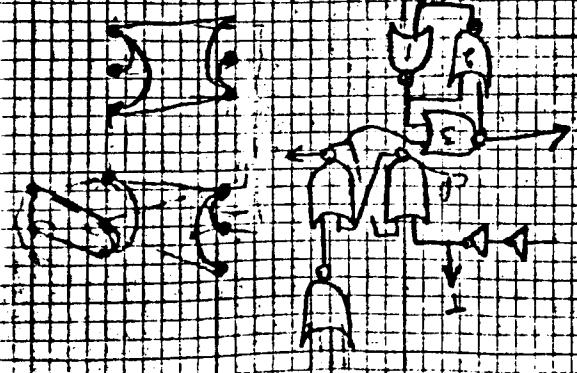

799
777
767

799
777
767

799
777
767

799
777
767

A-B STEINER

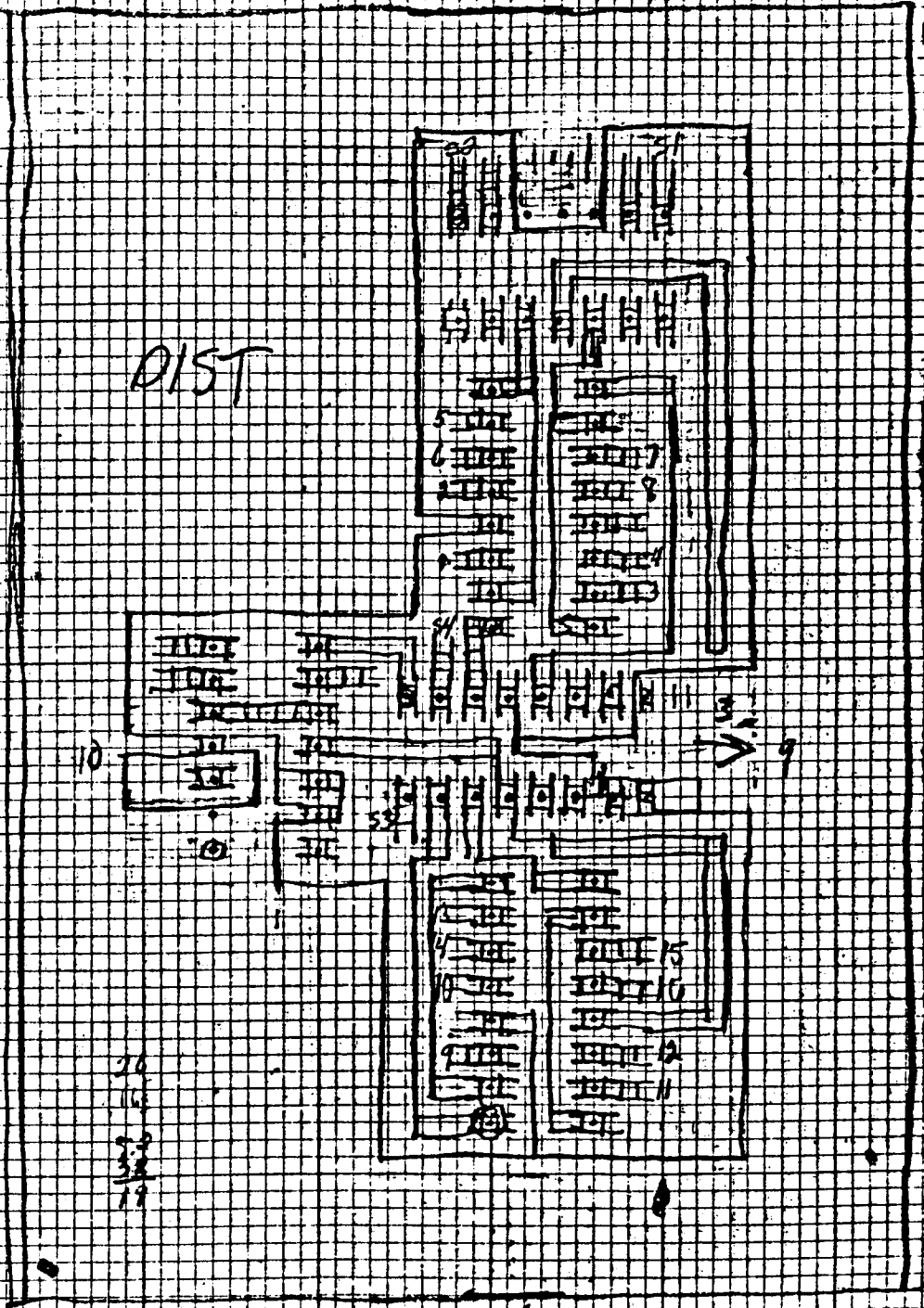
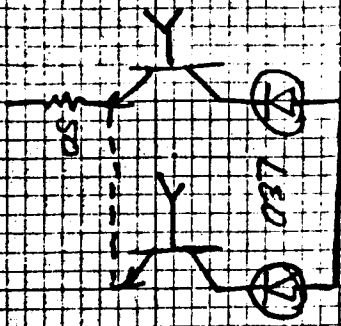

24
10
33
19

1/2 1/2

A-B SEQUENCE EA

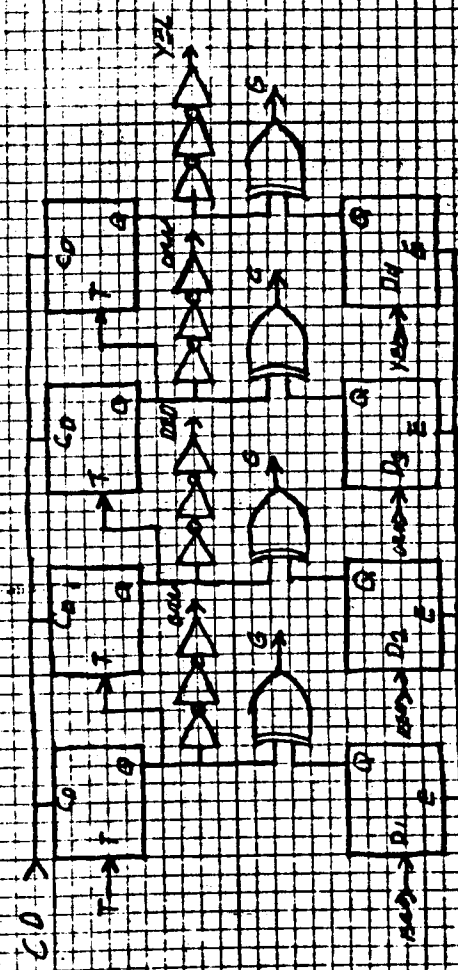

PROGRAMMABLE
1-15 COUNTER

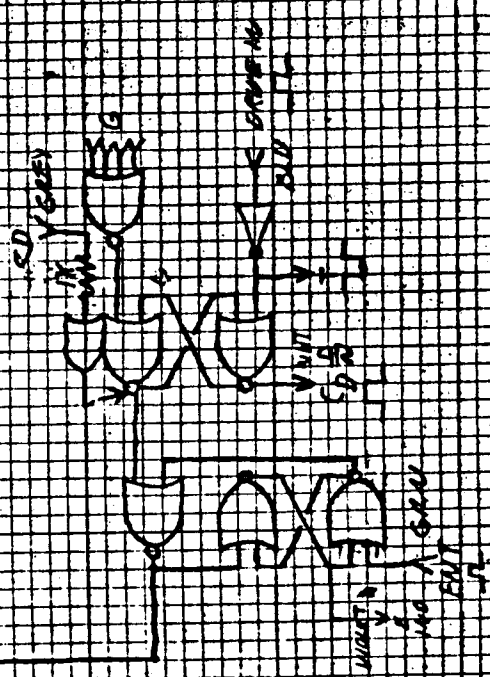
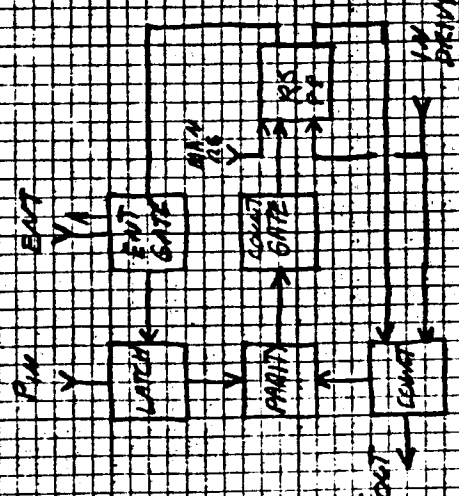

A-B STOPWATCH

0-15
PROGRAMMABLE
STOP COUNTER

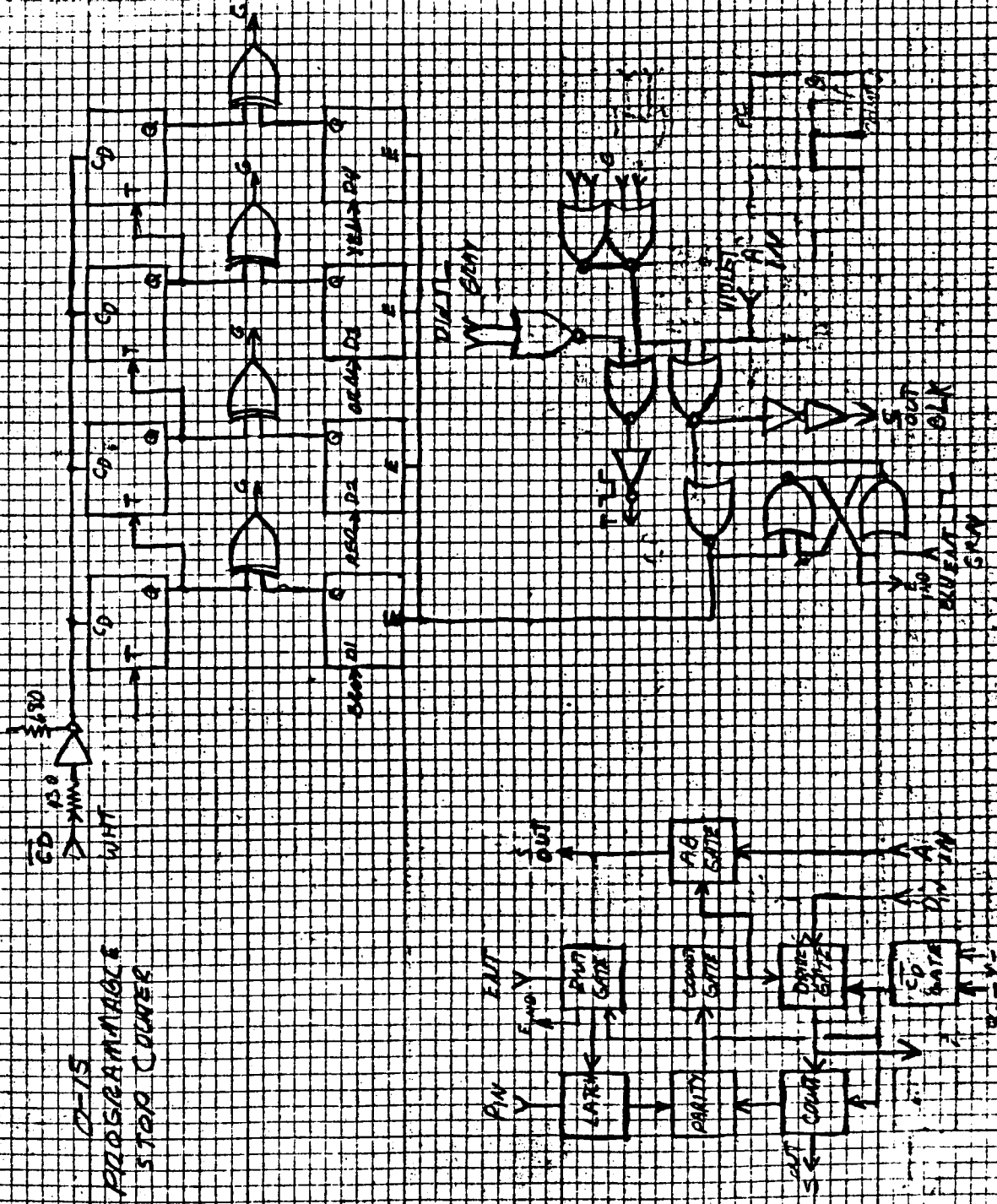

A=B SEQUENCER

15 LINE DISTRIBUTOR

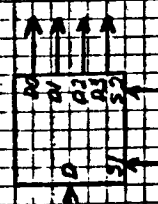
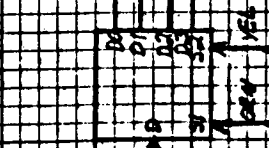
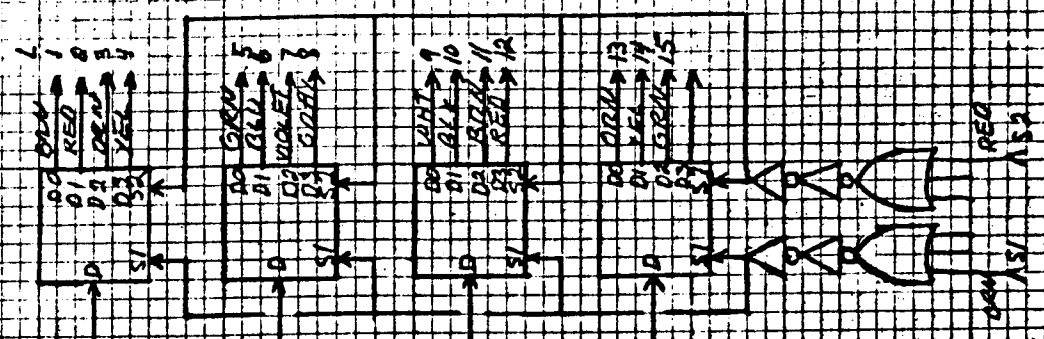

A-B

SEQUENCES

GEORGE BROWN

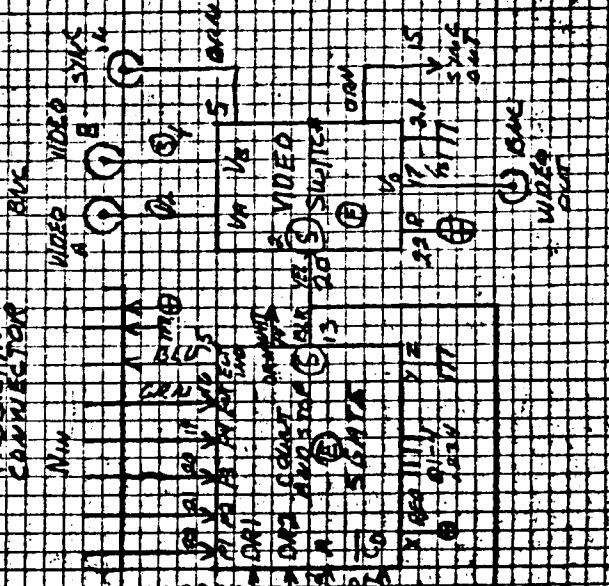
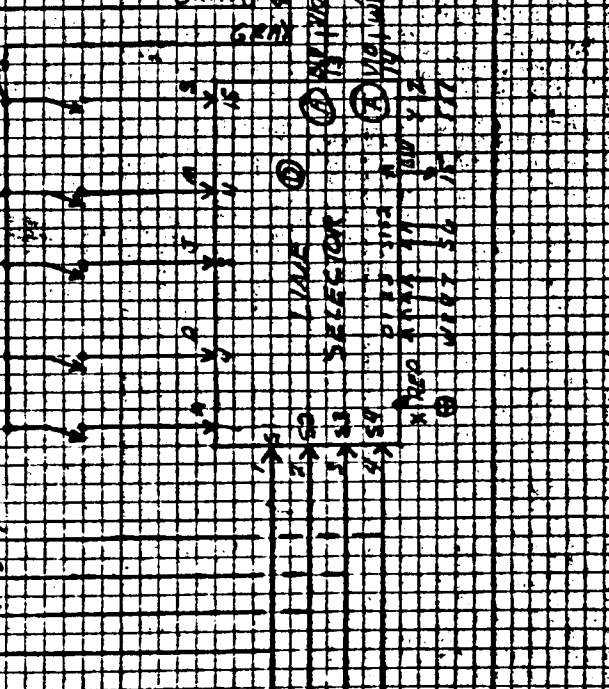
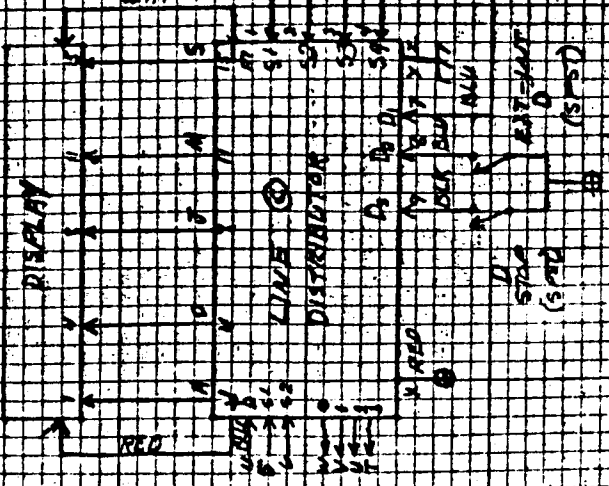
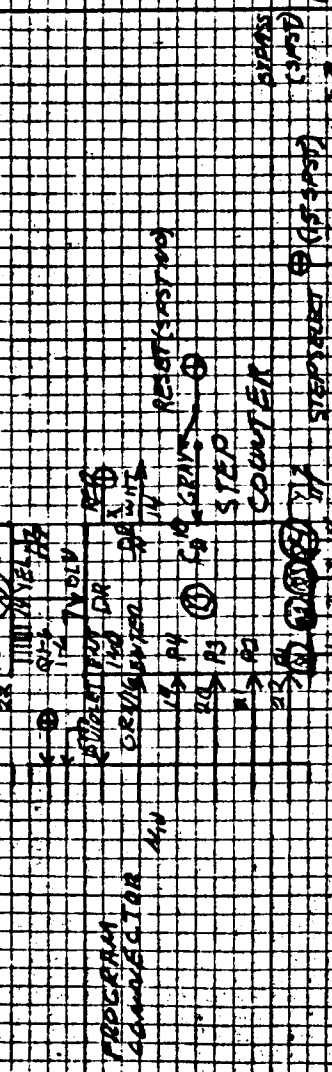
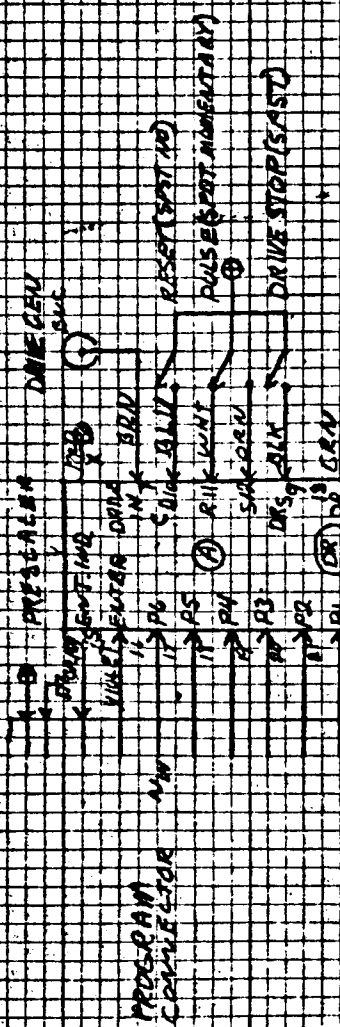

A-B SEQUENCE

15 LINE
SELECTOR

