

Welcome to the studio. This manual has been put together to help explain how to use the Video Image Processing system. The explanations and descriptions vary in depth and technical complexity.

Since you will actually be "constructing" the system through the method of patching together discrete modules, you must have a well-defined concept of signal flow in order to take advantage of the flexibility of the system. The heart of this process of patching together different modules is the matrix video routing system. This is a set of manually operated slide switches that is easy to use and understand once the concept of signal flow is grasped.

A "video synthesizer" or "image processor" is a general term referring to an assemblage of individual video signal sources and processors, all of which are integrated into a single system.

There are three general categories of devices in the system:

- 1) Signal Sources - devices which output a signal used in the system to generate an image, a control signal or a sync signal.
- 2) Processors - devices which perform some operation upon the signals, such as gain or phase changes, and are often used to mix inputs and put out combined or processed signals.
- 3) Controllers - devices which generate signals which are themselves inputs to processing devices to control an aspect of the image. These devices can be analog or digital in nature.

A video source is any device which internally generates a signal that can be displayed, and includes cameras, decks, character generator or oscillator. A processor is a device which either changes the parameter of the incoming signal (e.g. gain, polarity, waveshape) or combines two or more signals and presents them to the output (e.g. mixing, switching, wiping). Video processors include keyers, VCAs, mixers, colorizers, sequencers, SEGs and frame buffers. These terms are not absolute but have meaning relative to one another. A signal can be routed through processors in a linear order. A source goes into processor #1 and the output of processor #1 goes into an input of processor #2. Processor #1 may then be considered the source for processor #2.

SIGNALS

Signals have direction: that is, they are originated, are passed through devices and eventually wind up at a device which transduces, or changes, the signal into a form of information that is directly meaningful to our senses. In the case of video, the electrical signal is changed into information by the video monitor which our eyes understand as light and ultimately pictures. The video image itself does not travel through the machine, rather it is an electronic signal which represents the image that travels. This signal originates in a video camera or

some other type of signal generator such an oscillator in the Analog Synthesizer (for more information, please see the Analog Control Section). The place the signal is taken out of on any device is called the OUTPUT. Once we have generated the signal, it must be sent to a device that can use the information it contains. The place where the signal gets connected is called the INPUT. Inputs and outputs are general characteristics of all devices. The OUTPUT of a camera gets connected to the INPUT of a monitor. The image from the camera is displayed on the monitor. The OUTPUT of a camera gets connected to the INPUT of a deck and the OUTPUT of that deck gets connected to the INPUT of a monitor. The image from the camera is fed first to the deck and recorded and then displayed.

Types of Signals

The three main types of image processing signals are:

- 1) Video signals - those which contain the complete information necessary for a monitor to construct an image
- 2) Sync signals - those containing structural, rather than picture, information, which when combined with picture information allows it to be stable and rectangular.
- 3) Control signals - those which contain information for the control of processes.

SYSTEM

An image processing system is then a collection of devices the structure of which includes:

1) SYNC A common source of sync signals from a sync generator and a method of distributing that sync to all the sources and processors which need them. If you are processing a prerecorded videotape, then genlock is required on the sync generator.

2) ROUTING A method of routing the video signal through all of the processors. Ideally this should allow for flexibility and variability in the signal flow. Considerations include:

- a. One source can go to several processors simultaneously.
- b. Any combination of sources can be used with a multi-input processor.
- c. The order of signal flow through the various processors remains flexible.

3) An OUTPUT AMPLIFIER at the end of the line of processors standardizes the final video signal, correcting it for recording.

4) A method of MONITORING the parameters of the composite video signal coming from the output amplifier. These parameters include:

- a. Waveform monitor: gain, pedestal and DC bias of the video signal and sync information.
- b. Vectorscope: saturation and hue, and color sync information
- c. Video monitor: luminance and contrast of the signal

Color bars and gray scale are signal sources which are reference signals used when adjusting the three monitoring devices so that they are consistent.

5) A method of CONTROL over the processors to change the parameters of an incoming signal. There are two categories of control: manual control or voltage control. Voltages can be generated by analog or digital devices. The parameters are:

a. continuously variable using a potentiometer or knob as a means of manual control. Gain and pedestal knobs are examples.

b. one of two possible states using a switch or pushbutton as a means of manual control. Key on/off or normal/reverse are examples.

c. more than two discrete states using a rotary switch. Key clip select and sequencer rates are examples.

I. SYNC

Almost all devices in the image processing system need sync or synchronization signals to operate properly. Sync originates in a system sync generator and is sent out through distribution amplifiers to all devices requiring sync. All sync interconnections are made via BNC-BNC coax cables and are normally already patched for you. The main system sync generator has a color gen lock capability which means you can use one prerecorded videotape as a direct source.

The six NTSC sync signals are:

- 1) Composite Sync (Sync or S)
- 2) Composite Blanking (Blanking or Bk)
- 3) Vertical Drive (V.D., V. or Vertical Sync)
- 4) Horizontal Drive (H.D., H. or Horizontal Sync)
- 5) Burst Flag (B.F.)
- 6) Color Subcarrier (S.C., Subcarrier or 3.58 MHz Sync)

Sync Distribution

There are two ways to apply sync to all of the devices which need it.

1) In parallel The six outputs of the sync generator go directly into a sync distribution amplifier. This device then has several outputs for each of the six inputs and can go separately to the sync inputs of each of the video source and processing modules. The sync inputs of these modules must then be terminated individually.

```
Sync      ---> Sync Distribution --> Processor 1 (terminated)
Generator  Amp      --> Processor 2 (terminated)
                        --> Processor 3 (terminated)
```

2) In series In this case each of the six sync signals is looped through from one processing module to the next in a specific sequential order. With this method, none of the sync inputs to the modules should be terminated until each sync signal reaches the end of its line in the sequence. That signal must then be terminated at the last processing module to use it. Unlike parallel distribution, if the line for any sync signal is

interrupted, all of the modules from that point on will no longer have that particular sync signal.

In the Center's system, sync is distributed primarily by the serial method. Exceptions are the Paik/Abe Colorizer and Rack #3 which contains the Four Channel Sequencer and sync to the black and white cameras. On these modules a small sync distribution amplifier is used for parallel distribution of sync to these devices.

The Panasonic SEG contains the sync generator for the system.

Termination

A commonly used video connection scheme is the looped-through input, sometimes called a bridged input. This set-up facilitates ease in formulating multiple connections while maintaining the ability to "terminate" the video signal. Termination is required at the farthest input. This is usually done by connecting a terminator to the remaining bridged connector. Sometimes a switch is provided on a monitor input for termination, labelled "75 ohms" in one position and "high" in the other. The 75 ohm position is the terminating position. Notice that the two jacks in a bridged input are simply connected together and function only to "tee" the signal. Remember that the output sent along to another device is the same as the signal connected to the other jack, and should not be considered an output of the monitor.

Genlock

Sometimes it is desirable to take as an input to the image processing system a video signal from a pre-recorded videotape. The Center's system can take in one tape source at a time. Since the sync from the source is controlled from the point of origin (the VTR) it is necessary to "lock" the system sync to the sync from the source. A Genlock is required for this operation. It is important to understand that the sync on the material to be genlocked, the videotape, is the sync which is in effect controlling the system. For this reason it is important that the sync on the videotape which you are genlocking be as stable as possible. Usually the system will be more stable if the videotape is a good quality dub from the master. Second and third generation tapes or tapes with poor sync tracks will cause instability.

The output of the source VTR is patched to the genlock input of the SEG which contains the sync generator/genlock. For a 3/4" tape this is normally pre-patched. The genlock button on the SEG front panel needs to be depressed.

Genlock is also used for cameras which are not externally syncable. This includes most consumer cameras. The output of the camera goes to the genlock input of the SEG and the system will lock to the internal sync of that camera. A VTR cannot be used as a direct source since the genlock is occupied by the camera. The

tape must be rescanned.

The black and white cameras require horizontal and vertical drive. The sync inputs for the camera control units remain unterminated.

The SONY 1640 color cameras receive sync at the control units by serial distribution through a 10 pin cable. This cable also sends video from the camera back to the control unit. These cameras will not lock properly to an external source via genlock. These are the only two devices in the system which are incompatible with genlock.

The possible combinations of image sources in the system are:

1. Live black and white cameras alone or in combination with the color cameras.
2. One prerecorded tape in combination with live black and white cameras but NOT a tape with live SONY 1640 color cameras or any color camera which is not externally syncable.

When using the 1640 color cameras, the genlock button on the SEG should not be depressed.

Rescan

Outside video sources from videotape may also be rescanned rather than genlocked. This is done by playing the tape back on a monitor and pointing a camera at the monitor face. With this method you can mix a number of videotapes simultaneously and alter framing of the image. It causes degradation of the image quality.

The Raster Manipulation unit is a special type of rescan system allowing manipulation of the rectilinear quality of the image. This unit was popularized by Nam June Paik. It is discussed in the Raster Manipulation Manual.

II. ROUTING SYSTEMS

A routing system is used to patch different devices together, so that the output of one device is fed to the input of a second device. Processors generally have many inputs that may be used simultaneously but only one output. Any output from one device may be sent to as many inputs to other devices as you wish, however, two outputs should NOT be connected to the same input.

A routing system is a method of physically connecting one module to another to define the direction of the signal flow and the order of the modules through which the signal passes. Methods used are patch cords, switches or pin patch systems.

In the Center's system there are two routing systems: for the processors a matrix switcher is used and the final destination of the signal is the Jones Output Amplifier. The second routing system routes the video signal after it comes from the Jones Output Amplifier. It puts the signal into various monitoring and recording components. It uses a patch panel and cables and includes a video distribution amplifier as a way of sending signals to many devices simultaneously.

Video signals must be terminated at their destination points. The method for termination differs in the two routing systems.

A. Image Processing System Routing Matrix

There are many hundreds of possible combinations of signal routing on the matrix. The flexibility of this system is an important part of the creative potential of the system.

Patches begin with primary sources (camera, genlock etc) and end at the output amplifier. The number or order of intervening modules have few limitations. Feedback loops should be avoided. That is: one source goes into processor #1 and the output of processor #1 into processor #2. A feedback loop occurs if the output of processor #2 is fed back into processor #1.

The matrix has 58 outputs and 40 inputs accessible at the back panel. Outputs are numbered 1 through 58 and are already physically connected with BNC cables to all of the inputs on all of the image processing modules, for example the eight individual channels of the sequencer or the six channels of the colorizer.. The inputs to all of these devices remain unterminated. The outputs of these processing devices and of the image sources (character generator, cameras, genlock and video line converters) are connected to the 40 inputs on the matrix, labeled A - Z and AA - NN.

For reference, each module output is assigned a letter and is listed along the X or vertical axis of the front panel. Each input is assigned a number and is listed along the Y or horizontal axis. Each input has a slide switch which can be moved vertically along a column. That column lines up with that particular input. At the point where a switch is placed, it makes an interconnection between X and Y, a connection between the source listed at the left and the destination listed at the top.

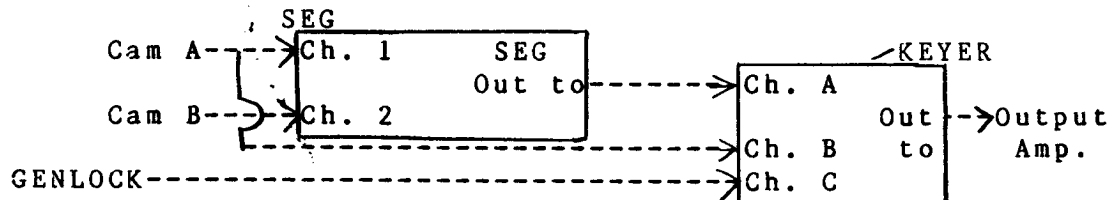

This is a flow chart of the following matrix configuration.

		Output Amp	SEG Ch.1	SEG Ch.2	SEG Ch.3	Keyer A	Keyer B	Keyer C
		1	2	3	4	5	6	7
Cam	A		x				x	
Cam	B			x				
Genlock	C							x
SEG	D				x			
Keyer	E	x						

A final destination is always the output amp. This is the only module on the matrix that you cannot take the output from. It is pre-patched to go to the second routing system for recording and monitoring of the signal.

You can have the same source go to different processors. Camera A is going directly to SEG Ch. 1 and Keyer Ch. C at the same time. On the matrix then many switches can be on the same horizontal line at the same time.

A module input can only have one source at a time.

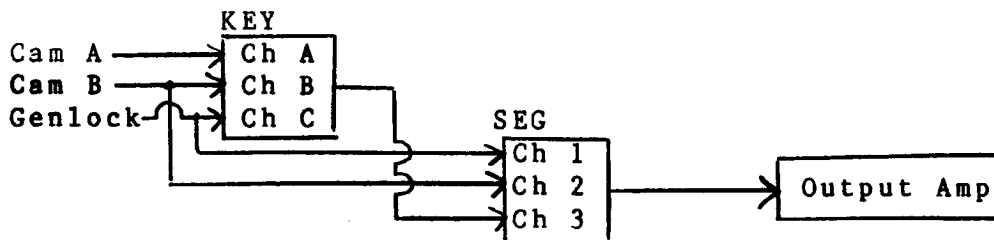

		OUTPUT AMP	SEG 1	SEG 2	SEG 3	KEYER A	KEYER B	KEYER C
		1	2	3	4	5	6	7
CAM	A					x		
CAM	B			x			x	
GENLOCK	C		x					x
SEG	D	x						
KEY	E				x			

B. Main Signal Routing System

This is discussed in the section "Monitoring the Signal".

III. OUTPUT AMPLIFIER

The output amplifier is the final destination of the signal in the system prior to recording. It offers a general control over parameters of the master signal out of the Image Processing system. This is #1 on the matrix. The output of this device is the main output of the system. It has four controls:

1. Pedestal-determines blackest level of signal

2. Gain-determines the range of gray levels in the signal
3. Input offset or DC bias-shifts the entire signal up or down within the allowable range from white to black.
4. Phase-adjusts the hue of color signals, shifting them in equal proportions.

Pedestal, gain and offset are adjusted using the waveform monitor. Phase is adjusted using the vectorscope.

The output amp was designed to limit the white level of the incoming signal if it exceeds an acceptable recording range.

To use:

1. Turn the gain down.
2. Adjust the pedestal level.
3. Adjust the gain to the desired level.
4. Adjust the input offset

IV. MONITORING THE SIGNAL

Three devices are used to check the signal coming from the output amp: the waveform monitor, the vectorscope and the color or black and white monitors. These are also used to compare the signal at two different points in the path, one coming directly from the output amp and the second after it has passed through the record deck.

A. WAVEFORM MONITOR

The waveform monitor does no processing of the video signal. It allows us to examine the quality of the video signal by giving us a graphic representation of the voltage of the video signal with respect to time. The waveform monitor is really a special purpose oscilloscope. Vertical distance on the waveform display represents voltage, while horizontal represents time. There is a choice of "strobe" times so that one field or line of the video signal can be observed.

Normally the waveform monitor is set to look at two horizontal periods, or two lines of video. What is seen is actually an overlay of many different lines. Within this, you can see the luminance and black level of the signal as well as the stability of the sync. Other settings show the vertical scan period and an enlarged view of color burst.

The diagram in the section "Sync" shows what one line of video should ideally look like. Of principle interest in the operation of the image processing system is the gain and pedestal of the output amplifier. The waveform monitor provides a way of monitoring these important parameters. The picture portion of the signal sits between 10 and 100 IRE units. A signal sitting at about 10 units is almost black. One sitting at about 100 units is almost white. A picture with a well balanced number of gray values has a waveform which occupies the entire permissible range of 10 to 100 units. A signal which falls much above 100 units or below 10 units will not record properly. The output amp will clip a signal that exceed 100 IRE units.

The timing of the signal is represented along the horizontal line. The time is measured in microseconds. The sync generator and output amplifier are preset to insure that the timing of the video signal is correct. There are no operator adjustments to be made.

B. VECTORSCOPE

A vectorscope shows the color portion of the video signal. It uses the convention of a color wheel to represent the signal. Chroma, or saturation, is indicated by how far the signal extends from the center. It should not exceed the outer circumference of the circle of noise may appear in the recorded signal a few generations later. The hues are marked at specific points, initialed M (magenta), R (red), G (green), Y (yellow), B (blue) and C (cyan). The vectorscope has a phase adjustment which places burst at 0 degrees. At this setting when color bars are patched to its input, the signal's six points will correspond to the marks.

C. MONITORS

There are several types of color monitors. There is also a bank of four black and white monitors, used as preview monitors. Their inputs are routed from four separate points on the matrix and are used to look at primary image sources, for example cameras. They can also be used to look at the output of modules in various stages of a patch. They do not indicate the signal coming from the output amp.

ROUTING THE SIGNAL AFTER THE OUTPUT AMP

The patch panel below the monitor bank is a routing system which distributes the main signal after it leaves the output amp. It allows you to put it into various monitoring and recording devices. There are two rows of jacks. The top row is outputs. The bottom is inputs. A video distribution amplifier is used. It has one input and puts out six identical outputs, which lets you send the signal to many places without having to loop through devices. As with the sync signals and the video signals in the matrix, whatever the system of distributing the signal, termination is necessary. In this case, the signal goes independently to each device and is then terminated at that device.

A standard patch is shown in the accompanying diagram. In this configuration, color monitors 1 and 3 always show the direct output of the system. When the waveform monitor is set for channel A, it and color monitor 2 show the direct output of the system. When the waveform monitor is set for channel B, it and color monitor 2 show the output of the VTR. The vectorscope has its own switch for Ch. A and Ch. B, which also show the output of the system and deck respectively. Its setting has no effect on color monitor 2's signal.

In this patch, there are still two available outputs on the distribution amp. By patching one into a VHS recorder, you can make simultaneous recordings on 3/4" and VHS.

The output of the SEG is also provided on this patch panel. This is the only video processor with an output which can bypass the output amp. It is routable on the matrix like any other device. The color bars from the SEG can be sent directly to the moonitors and deck without phase alteration from the output amp.

This section outlines a basic procedure for setting up the image processing system prior to recording.

ADJUSTING COLOR ON MONITORS

Patch the output of the SEG (on the patch panel) to the input of the distribution amp. Set the SEG to color bars.

Patch the separate outputs of the distribution amp to:

1. Waveform monitor and vectorscope Ch. A
2. Color monitors 1,2 and 3
3. SONY record VTR

Patch output of VTR to Ch. B of waveform monitor.

Adjust hue and chroma on each monitor for color bars.

Adjust phase on vectorscope so that hues are in correct locations.

ADJUSTING BRIGHTNESS AND CONTRAST OF MONITORS

Patch the output of the output amp on the patch panel to the input of the distribution amp.

Patch the separate outputs of the DA to:

1. Waveform monitor and vectorscope Ch. A
2. Color monitors 1,2 and 3
3. SONY record VTR

Patch output of VTR to Ch. B of waveform monitor

Turn power bar on for computer.

Place disk in drive A, label facing left.

Hit reset on D+7A until directory appears and you have "A>".

Type BARZ and hit return

Route the CAT Output to the output amp

Make sure waveform monitor is on Ch. A

Adjust gain, pedestal and input offset of output amp, until stair-step pattern on the waveform monitor is full range and is as linear as possible.

Adjust contrast and brightness controls of each monitor to display 16 gray levels.

PATCH PANEL FOR NORMAL USE

Use above patch except patch output of waveform monitor to input of color monitor 2

SYSTEM SOURCES

A. Prerecorded Tape

The output of the playback VTR is connected to the genlock input of the SEG. Usually this deck is connected directly to color monitor 2 so that when the VTR button on the monitor is depressed it shows the output of the deck before it goes through the system. Depress genlock button on SEG. On the matrix, route the output of the genlock to the output amp, and adjust output amp. Switching between VTR and Line settings on color monitor 2 will compare the tape signal before and after the output amp. When using a VHS tape as a source, disconnect the cable from the output of the 3/4" VTR and connect it to the output of the VHS deck.

B. Black and white cameras

The control units for these are usually pre-patched. The CCUs (control units) are labeled A through D to correspond to the matrix outputs. A multi-pin connector from the camera to the CCU provides power, sync and sends video from the camera to the system. If they are not pre-patched:

1. Connect one of the horizontal drive outputs from the camera sync panel to the H input of the CCU with a BNC-BNC cable.
2. Connect one of the vertical drive outputs from the camera sync panel to the V input on the CCU.
3. Connect the video output of the CCU to one of the inputs A through E on the back panel of the matrix.

Un-cap the camera. Turn the CCU on. Route the output of the camera directly into the output amp. Adjust gain and pedestal and F stop on the lens. When not in use, cover the cameras and turn the CCU power off. Doing one without the other can damage the camera.

C. Color Cameras

The two SONY 1640s are connected to the system by a 10 pin cable between the camera and separate rack-mounted control units. These cables send all six sync signals to the cameras as well as power and sends the video signal from the camera back to the CCU. These cameras cannot be locked to a genlock signal. To use:

1. Turn genlock off.
2. Connect the cameras to the CCUs with 10 pin.
3. Turn on the CCU power.
4. Uncap cameras and set filter to appropriate lighting condition.
5. Set lens opening ring to A for automatic exposure.
6. Set selector switch to Auto.

If there is a white band visible in the viewfinder, it indicates insufficient light.

7. To white balance, point camera at a uniform white area, set lens to A and focus. Turn the B and R white balance controls to that the balance needle is as far left as possible.

8. Look at the output of the cameras individually through the output amp and adjust.

Incorrect colors require either a white balance (colors tend to be shifted all toward one hue) or phase adjustment (wide range of hues but all shifted equally. First adjust white balance then phase. The chroma control on the CCU will provide more or less color saturation. Gain and pedestal controls on the CCU should be left in the center. Adjust these on the output amp.

D. Video Line Converters

The two video line conversion inputs are on one of the racks and can be accessed at the matrix. Patching any plus/minus 5V signal into these will attenuate the signal to .7V and add .3V of sync to conform to the 1 V P-p video standard. If the incoming signal is less than 10 V P-p, it will be proportionately less than .7V video signal.

Check all of your primary sources one by one directly through the output amp to make sure they match each other in terms of gains and pedestals. As the signals are routed to individual modules, look at the outputs of them through the output amp singly in the order in which the signals are routed. Check that the gain and pedestal settings at the outputs of these modules are similar to the signal's before going into the module. Most devices have gain and pedestal controls for each channel to compensate for differences.

NOTES ON COLOR SIGNALS

Every module that you pass a color signal through will change the phase of that signal. Since the output amp is always the final destination, you can readjust the phase to compensate for hue changes.

When mixing a live camera or color genlock tape with a colorized image, consider the last module in the system where the two signals will be combined. Looking at the module's output through the output amp, adjust the phase control so that the "real" color is correct. Then adjust the hues of the colorized signal with the controls on the colorizer.

Some modules will generate noise at their outputs when a color signal is routed through their inputs. These include the clip inputs to keyers and the inputs to the frame buffer. The noise with the keyers may generate useful effects. Do not use a color signal as input to the buffer. A color kill is used with a separate input and output on the matrix. This strips the chroma and the original color signal is still available from its point on the matrix. A monochromatic version of the signal is also available at the output of the matrix for routing into the buffer and key clips if desired.

VIDEO PROCESSING MODULES IN THE IMAGE PROCESSING SYSTEM

This portion of the manual begins a description of the video image processing devices available. If you plan to use any of your own equipment in the system at the Center, please confirm with the Center's Coordinator that the equipment is compatible, that necessary cables are available and that the correct patching method is used.

The categories of devices are:

- I. Voltage Controlled Amplifiers
- II. Sequencers
- III. Keyers
- IV. Colorizers
- V. SEG
- VI. Buffer
- VII. Character Generator (although really a signal source, this device will be described in this section)

The categories are not exclusive. For example, some of the simpler devices are actually built into the more complex. Keyers contain VCAs. Colorizers, SEGs and frame buffers may contain keyers. The inputs and outputs of all these devices are routed through the matrix. Although the technique of voltage control is discussed throughout, the concepts of analog control voltages are discussed in that section of the ETC manual along with a description of the Jones Oscillators.

SIGNAL STANDARDS

The following module descriptions will at times be technical in nature and require some knowledge of electronic signals.

The two signal standards used in our devices are:

- 1) Video signals - NTSC standard 1 volt P-p
- 2) Control signals - electronic music standard, 10 volts P-p

Some devices deal with only one type of signal, while others deal with both. It is the function in many cases for processing modules to combine video and control signals. The image processing system is really a system for controlling the mix of electronic signal elements which finally determine an image.

I. VIDEO VCAs/MIXERS

VCAs are the simplest type of processor in the system. They are 1 input/1 output devices which control gain, pedestal and polarity of the incoming signal. They are used to:

1. manually adjust gain and pedestal of a video signal before sending it to a processor with no VCA. This helps to balance the input signals relative to one another. Examples: 4 Channel Sequencer inputs or SEG.

2. voltage control the gain of a signal before sending it to a processor with no VCA. Example: Paik/Abe Colorizer

3. change the polarity of a signal from positive to negative either manually or automatically. Results in reversed gray levels

and complementary colors with a color signal.

4. fade the video signal between black and full gain.

5. function as a voltage-controllable mixer for cross-fading, when using 2 or more VCAs, along with a video mixer.

VCA Panel Controls:

GAIN Center position is 0 gain. When P/N switch is in P position, left is negative, right is positive.

VCA INPUT Accepts any plus/minus 5V signal from the analog control system and has an attenuator for limiting sweep of the control voltage.

PED Manual control only

P/N Inverts signal

A. Fade from Positive to Black

1. Select video input to VCA at matrix

2. Set P/N to P

3. Set gain to 2 o'clock position

4. Adjust pedestal, while viewing waveform monitor

5. Apply control voltage to VC input. The waveshape will determine the transition. Sine wave will fade continuously up and down. Positive ramp will gradually fade up and jump to black.

6. Adjust attenuator so that CV sweep covers full range on waveform monitor. If the CV sweeps the signal into the negative range, turn the attenuator and readjust the gain. This functions as the bias control and determines center of sweep.

B. Cross-Fade Between Two Video Signals

The two control signals will always be 180 degrees out of phase. The first VCA will be full gain when the second VCA is at zero gain.

1. Follow above using positive sine or triangle out of Jones Oscillators.

2. Select a second video signal into another VCA and repeat same steps using negative output from the same oscillator and the same waveshape.

3. Route the outputs of the two VCAs into two inputs of the mixer on the matrix.

4. Adjust polarity, gain and pedestal of the mixer.

C. Voltage Controlled Polarity

VCA 1 and the mixer will sweep continuously from positive to negative. VCA 2 and VCA 3 will not. There will be a disturbance at zero gain.

1. Set gain to center. P/N switch is arbitrary

2. Adjust pedestal

3. Adjust attenuator to full clockwise

4. Apply continuous control voltage to VC input and adjust frequency. The VCA accepts control voltages >60 Hz.

D. Automatic Switch from Negative to Positive

This patch allows vertical interval transitions from positive to negative but will not allow control voltages >60Hz.

1. Follow steps 1,2,3 above

2. Patch output of square wave to the In on the sample and

hold module.

3. Patch vertical drive output to the CK jack or clock input of the sample and hold.

4. Apply the output of the sample and hold module to the VC input of the VCA and adjust frequency of oscillator.

Mixer

The mixer is a 4 input additive mixer. It takes the gray levels of each of the incoming signals and averages them at the output for a superimposition. Controls are the same as those of the VCAs. There are no individual gain controls for the inputs.

II. SEQUENCERS

A sequencer is a multi-input device which switched from one input to another automatically. The number of inputs and rates of switching vary with the device. There are two basic devices in the system.

A. Jones Sequencer

Description

The Jones Sequencer is an eight input, one output voltage controllable switcher. It uses three different methods of control for selecting the input and presenting it to the output. The first method, or the "sequence" control mode, will step through the channels (numbered 0-7) in numerical order using a 2 to 8 step pattern and then repeat this pattern indefinitely. In this mode the inputs are always presented in the sequential order that is selected at the matrix. A second method, the "binary" control method uses a three bit binary system to select the order of the channels, allowing more complex and possibly non-repeating patterns of switching to occur. In the third mode, the device is operated as a manual switcher.

When using voltage control, the rate of the sequence, as determined by an external clock such as an oscillator, can range from extremely slow with vertical interval switching, up to several multiples of the horizontal frequency which allows juxtaposition of signals within divisions of the raster.

Although the sequencer is mainly used as a video signal processor, another application of this device is to switch among 8 separate signals using the mini-jack inputs and outputs on the front panels. These signals must be within the range plus/minus 5 volts and can be control voltages, audio signals or oscillator-generated shapes. The device is compatible with the Analog Control system in the Image Processing system as a signal processor or signal generator.

How to Use the Sequencer

The numbers in parentheses indicate the controls on the front panel of the sequencer, shown in Figure 1 Sequencer.

SWITCHER MODE

Manual Control in the Switcher Mode

Select the video inputs to each channel at the matrix. Select the method of sequencing. Start with switch (1) in the down position,

marked "switcher". Set control (2) in the down position, marked "switch". This allows manual control.

Pushbuttons (9)

In this mode the pushbutton controls allow you to choose each channel individually in any order. The corresponding lights, or LEDs, will indicate which signal is being sent to the output.

Output Pedestal (8)

Adjust the pedestal control knob for the video output.

Channel Pedestals (10)

Step through each channel and adjust the pedestal control knobs for each input.

Vertical Interval Switching

Sync Input (4) and Sync Modes (3)

For vertical interval switching (VIS) a sync source and sync mode need to be selected. The sync input (4) requires vertical drive, usually patched from the output jack marked "V.D." on the Analog Control System. For manual control in the "switcher" mode, set the sync mode select (3) to the "1" position to allow vertical interval switching.

SEQUENCE MODE

Set the sequence/switch switch (2) to sequence, or the up position. The binary/switcher switch (1) will not function. Select the number of steps in the sequence. In this position the pushbuttons (9) will select what the last channel in the sequence will be, before returning to channel 0. Remember that selecting channel 5 makes it a six-step sequence.

Count Input (5)

Patch the output of an oscillator into the input mini-jack marked "count". This sequence will divide the frequency of the incoming signal in half. That is, the rate of the sequence will always be twice as slow as the original signal from the oscillator.

Sync Modes (3)

Select the sync mode according to the sequence rate in the following way:

Below 60 Hz

For rates which are below 60 Hz, or the field rate, sync modes "1" or "2" can be used. As the control voltage approaches 60 Hz, the sequence rate will behave differently within these two modes. In sync mode "1", harmonics between the sync and count pulses will occur causing the rate of switching to actually slow down as the "count" pulse approaches the 60 Hz threshold. In sync mode "2", no harmonics will occur, and the sequence rate follows the count pulse accurately up to the threshold. Neither mode will allow rates of switching above 60 Hz.

Above 60 Hz

Sync mode "0" will allow signals greater than 60 Hz or field rate as the count pulse. This will divide the raster and permit switching within the frame. Rates right above 60 Hz will yield horizontal bars, presenting each input in succession from the top to the bottom of the screen. To lock these bars, vertical drive must be applied to the sync input of the oscillator which is acting as the external clock because this module can accept much higher frequencies than the four-channel sequencer. Combinations of externally syncable oscillators can be mixed together to create shapes, such as boxes and used as the count input. This will yield a variety of multiple split-screen images.

60 Hz

In sync mode "3", the sync input becomes the clock pulse. With vertical drive patched into the sync input, the rate of switching will always be at 60 Hz.

BINARY CONTROL MODE

Binary Control A, B and C (6)

Set switch (2) in the down or switch position. Set control (1) in the "up" position, marked "binary control". In this mode the sequencer uses binary logic to choose which input is sent to the output. The controls are three two-position switches with corresponding voltage control inputs. The controls represent 3 bits of data, in which there are 8 possible combinations of on-off positions. Figure 2 is a table which shows the relationship of these on-off positions to the channel numbers of the sequencer. "Switch C" is the least significant bit. "Switch A" is the most significant bit. 0 indicates the off or down position, and "1" indicates the on or up position.

Control Voltages and Sync Modes (3)

Control voltages can be applied to one, two or all three of the input jacks simultaneously. Signals going into the "count" input (5) have no effect in the binary control mode. Figure 3 uses an example in which 3 asynchronous pulse waves are being patched into jacks A, B, C respectively. Lines 1, 2 and 3 show their waveshapes in respect to time, line 4 shows the resulting binary number and line 5 shows which channel number is being sent to the output for each period of time.

Below 60 Hz

For control voltages below 60 Hz, sync mode "1" and vertical drive patched to the sync input will allow vertical interval switching.

Above 60 Hz

Sync mode "0" will allow control voltages above 60 Hz. Figure 4 shows the output of three externally synced oscillators displayed on the raster. The first and third are at frequencies above the horizontal and the second above the vertical rate. The fourth image shows the division of channels within the raster when these three oscillators are applied to binary control inputs A, B and C respectively.

Combined Voltages

The binary input control can also accept combinations of control voltages above and below 60 Hz. Figure 5 shows an example in which 2 oscillators, combined to generate a box shape, are applied to input B. A second slow-varying control voltage is applied to input C. When the second control voltage is low the combination of channels 0 and 2 is seen. When the voltage is high, the combination of channels 1 and 3 is seen. Note that for this application, either mode "0" or "2" must still be used. In order to have vertical interval switching for the slower control voltage, it must be patched into a sample and hold module beforehand, with vertical drive as the clock input.

SWITCHING OF PLUS/MINUS 5 VOLT SIGNALS

Finally, an alternative use of the sequencer is to step through or switch among a set of plus/minus 5 volt signals. In this application, the input jacks (11) can take in a plus/minus 5 volt signal (for audio, control voltage or shape) at each channel. These are accessed at either of the plus/minus 5 volt output jacks (7). With no inputs to these jacks the module can still step through a series of eight DC control voltages which are preset with the pedestal control knobs (10) of each channel. All three modes of switching can be used and triggers can be sent to the sync input (4) for synchronizing a number of control voltage events in time.

FIGURE 1 on separate page.

B. FOUR CHANNEL SEQUENCER

The design and features are different from the Jones 8 Channel. There are no individual pedestal controls on the four channels. There is no output pedestal. The input signals are always presented to the output in the order selected at the matrix. There is no binary control mode. This is a video sequencer only. It cannot be used to sequence plus/minus 5V signals. There is an internal clock for the switching rate and an option to use external clock or count pulses. It will not accept clock rates as fast as line rate but will take frequencies up to several multiples of field rate.

How To Use

1. Select inputs at matrix.
2. Select number of steps in the sequence with the three position switch. Up is for 2 steps; down is 3 steps; center is

for 4 steps. The sequence always starts at channel 1.

3. Set switch to Hold

4. Press Step button to manually step through each channel. The LED shows which inputs is sent to the output.

5. Set switch to Count for sequencing.

6. Select clock source.

7. VD:

In VD position, the 17 position rotary switch marked halves the rate, or doubles the time each image is present.

8. Ext:

In Ext position, the negative ramp generator is the clock, by using the Rate knob. In this mode, the rate is continuously variable and is voltage controllable. Switching rates faster than 60 Hz can be used.

9. Ext:

When an external pulse is patched to the jack marked Ext, this will override the ramp wave generator as the clock and will becomes the count pulse.

10. When using ramp generator or external pulse:|

1. Set ./ . switch to left

2. For rates <60Hz set SYNC:SEQ to Up for vertical interval switching.

3. For rates >60Hz set to down position for higher frequencies to pass, producing bars of images. To lock the bars, set SYNC/OSC switch up to apply sync to the ramp generator. To let bars roll, set switch down.

III. KEYERS

Keying is a process of graphically combining video signals. It originally was developed in the television industry for the purpose of electronically imitating a filmic technique known as matting. In this context, the most conventional use has been to take two camera images and juxtapose them in a way which creates the illusion of a single, continuous three-dimensional space. Thus keyers are often referred to in terms of placing one image "behind" an object in a second image or of "inserting" an image "into" an area of another image. Using a keyer, you can create a shape in a first image, by defining the gray values that comprise that shape, and then remove all portions of the image within the boundary of that shape. Into that hole you can then insert the portions of a second image which spatially correspond if the two images were to be superimposed.

The development of a keyer as a three-input device, with voltage controllable parameters as well as its use in an image processing systems necessitates a broader understanding of the functions of a keyer.

How a Keyer Works

There are three channels in the luminance, or black and white, keyer: two main channels, A and B, and a clip input. Each of the main channels is a VCA, or voltage controlled amplifier, which sends the incoming signal to the same electronic switch. At any given moment, this switch chooses either signal A or B at its output. The rate of switching is fast, taking place several times within each horizontal line of each frame. The video signal that

is going into the clip input controls this switch. A clip level determines a certain threshold point, and the clip input signal is compared to the threshold. It is the voltage levels of the signals that are being compared. When displayed on the raster, these voltage levels become the gray levels of the image. The comparison is being made at each point on each horizontal line. When the voltage of the clip input signal exceeds this threshold point, and the signal is therefore brighter than a pre-determined gray level, channel A is presented at the output of the switch. When the voltage of the signal falls below the threshold, and is therefore darker than a certain gray level, channel B is seen. Moving the clip level control knob clockwise increases the threshold point. This allows more of B to be seen than A. Thus channels A and B will always be on opposite sides of the clip edge. A key reversal simply exchanges the positions of channel A and B relative to this threshold point.

Internal and External Keying

The conventional use of a keyer as a matte device is a specific case in which one of the two signals going into the VCAs is also being used as an input to the clip channel. This technique is often referred to as internal keying. Some keyers are hardwired in a way which allows internal keying only. When a third signal, separate from either of the VCA input signals is patched to the clip input, this is called external keying.

Wipes

Split-screens are a specific application of external keying. An externally synced oscillator is used as the clip input signal to switch between the two main channels. A continuous change in the threshold point, or clip level, from low voltage to high voltage, or vice versa, is often called a wipe.

A. Jones Keyers I and II

There are two Jones Keyers located in the case with the Sequencer, and they both function in the same way. Figure I shows the front panel controls of the keyers. Both are hard-edge, luminance keyers. The clip input can either be routed from one of the two main channel inputs for internal keying or from a third and separate source for external keying. This is determined by a three-position clip select switch (5). Each of the two main channels is a VCA with separate gain (6) and pedestal (7) control knobs. The clip channel has a clip level control knob (3) which determines at what gray level the transition between channel A and channel B will take place. There is also a two-position switch to allow you to use or by-pass the clip (1) and a switch for normal and reverse keying (2). All of the parameters except the clip input select are voltage controllable. The modules are designed to accept plus/minus 5 volt signals with frequencies up to several multiples of the horizontal line rate. The voltage control input (4) for the clip level has a built-in attenuator for adjusting the range of the wipe. All of the knobs will bias the associated incoming control voltage.

How to Use the Jones Keyer

1. Select the channel inputs at the matrix.
2. Set the on/off control (1) to the down or off position. In this mode the clip input is by-passed and the normal/reverse control (2) acts as a two-input switcher which is either manual or voltage controllable.
3. Set the N/R control (2) to the up or normal position. This will present the input signal of channel A to the output.
4. Adjust the gain (6) and pedestal (7) control knobs on channel A for the desired range.
5. Set N/R control to the down or reverse position. This will present the input signal of channel B to the output.
6. Adjust the gain and pedestal control knobs on channel B.
7. Select the clip input (5).
For internal key, choose position A or B.
For external key, select the input at the matrix and also set the clip input select switch to C
8. Set the on/off switch to on.
9. Set the N/R switch to normal.
10. Adjust the clip level control knob.

B. Jones Keyer III

This is a hand-wired prototype. Its functions are similar to the other keyers, except the front panels are arranged differently. All the VC inputs are on the left. Jacks marked "G" and "P" 1 are the VC inputs for the gain and pedestal of Ch.A. "C" is the VC input for the clip level etc. There are no built-in attenuators for the VC input of the clip, as with Keyers I and II.

C. Keyers IV and V

These are also 3 input voltage-controllable luminance keyers. They differ from the others in the following ways:

1. There is no clip select bus. The signal input to Ch. C of that keyer on the matrix is the clip input. The signal acting as the clip input must be routed to Ch. C as well as into one of the VCA channels with the second signal into the remaining channel, even for internal keying.

2. There are no separate pedestal controls for each channel. The BAL control determines the relative pedestal levels of the two VCA channel inputs.

3. The key On/Off and key Normal/Reverse controls are only manual; they are not voltage controllable.

There are separate gain controls for each VCA channel and a clip level control for the clip channel. Along with the balance, these are voltage controllable. There are no built-in attenuators for the VC inputs.

IV. COLORIZERS

A colorizer takes as its input a black and white video signal, then adds color in a fashion according to the type of colorizer. Usually a colorizer unit contains other video processing as well, such as negative video, keying, mixing. The

two colorizer systems at the Center are described below.

A. Jones Colorizer

Description

The Jones Colorizer is a multi-functional image processing device which can accept up to six video signals, add a color of separate hue and intensity to each signal and combine them at a single output by a variety of techniques including cross-fading, multi-level keying and two types of mixing. Each of the six channels can control gain and pedestal levels of the incoming signal, choose a hue from a three color system to mix it with and key the colorized image using either the original input signal or an input from any of the other five channels as the clip source. Additional controls include the polarity of the signal, saturation of color, the clip level and the softness of the key edge. All of the parameters, except image polarity and clip input select, are voltage controllable and can accept very high frequency control voltages.

How Each Channel Works

Each of the channels functions in the same way, as shown in Figure 1.

Polarity, Gain and Pedestal

A video signal selected at the matrix goes into a voltage control amplifier or VCA (Figure 1, I) where the polarity can be changed by a switch on the back panel marked "normal" and "negative". The negative position reverses the gray level values of the image. The gain and pedestal of the image are also controlled here by two knobs, located in the upper left hand side of each channel.

Red, Green and Blue Gains

Color is derived from the subcarrier information supplied by the sync generator in the Image Processing system. The 3.58 MHz signal goes into an RGB encoder (Figure 1, II) which splits the signal into three separate hues: red, green and blue, the primary colors of video. The accuracy of these hues at the output is relative to the adjustment of the phase control on the main output amplifier in the Image Processing system. The three color controls will always represent hues 120 degrees apart on a color wheel. The phase control on the output amplifier rotates all of the hues of this color wheel at once. At the proper setting the outputs of the encoder will be red, green and blue, which are mixed in various proportions through a color mixer (Figure 1, III) by the three color gain pots. The combination of any two of these signals will yield secondary colors. For example, red plus green equals yellow, blue plus red equals magenta and so on. The combination of all three hues is white. Therefore, all three pots turned up will cancel each other out.

Chroma

The output of the VCA and the color mixer are combined

through another mixer (Figure 1, IV) where the intensity or saturation of the color is determined by the chroma knob. Finally, this colored signal goes into one channel of a keyer (Figure 1, V) with black going into the other channel and a clip source that makes either a soft or hard edged transition between them. This clip source can be derived from either the original signal or from any of the other five inputs.

Clip Select and Clip Level

Figure 2 shows how the clip select system works. Each input to the colorizer is split seven ways. The first goes into the designated channel to be colorized. The other six go into the individual clip select busses for each channel. Therefore, each channel has the same number of options for a clip source selected by a six-position rotary switch for that channel. If the same signal is chosen for the clip input as for the main channel input then the keyer will mask out the whitest areas of the image, passing only those portions of the colorized image which fall below a certain gray level. This gray level is adjusted by the clip level control. If one of the other five input signals is chosen as a clip input, that signal will determine the cut-out shape between the colorized image and black. Even though the maximum number of signals combined at the output is still six, the possibilities of combinations within a channel and between two channels is greatly expanded.

Key N/R

Keyers on channels 1,3 and 5 are pre-set to key out the whitest areas of the clip signal first. That is, when adjusting the clip level control on these channels for a specific gray level, black will be inserted on the screen anywhere whiter than that gray level. The colorized signal will remain anywhere blacker than that level. Channels 2,4 and 6 are pre-set to key out the blackest areas of the clip signal first. The clip input is still determined by the clip select bus for each channel. Changing the polarity of the VCA input will not affect the key orientation.

Hard/Soft

The "hard/soft" knob controls the amount of discreteness in the border between black and the colorized signal. The counter-clockwise position allows a fully dissolved or continuous transition.

Additive and Diode Mixing

The output of each channel goes into a main mixer which uses one of two methods for combining the signals. An additive mixer is the type most widely used in Special Effects Generators. In this case the gray levels of each of the incoming signals is averaged out for each point in the frame. Diode mixing is a more selective process where only the brighter areas of each channel pass through. A two position switch on the top panel makes the selection between these two forms of mixing.

Master Gain and Pedestal

The final stage of the colorizer is an output amplifier where the master gain and pedestal can be controlled.

Operating the Colorizer

1. Set the clip select switches of each channel to the corresponding input of that channel. Set Channel 1 clip select to "Ch 1", Channel 2 to "Ch 2" and so forth.
2. Set all of the polarity switches on the back panel to the "normal" or up position,
3. Turn the "hard/soft" knobs of each channel to the clockwise position. Set the chroma switch to the back for diode mixing.
4. Turn all of the other pots on each channel to the counter-clockwise position.
5. Set the master pedestal control to center position and the master gain control to the center position.
6. Select the input for Channel 1 at the matrix, look at the signal directly through the output amplifier first before going into the colorizer to see that the gain and pedestal are within the proper range.
7. Look at the output of the colorizer and adjust the gain and pedestal controls of Channel 1. With Channel 1 gain set in the center, the range of the pedestal is from 12 to 4 o'clock or about 120 degrees. Any setting above or below this will not show anything at the output of this channel. Select the pedestal level, checking the waveform and video monitors.
8. Turn the chroma control to approximately the center position.
9. Turn the red gain knob clockwise.
10. Adjust the master phase on the output amplifier until the hue is red. Look at the vectorscope to see if the signal is in the range of the "R" hatchmark.
11. Turn down the red control knob and turn up the green and blue control knobs separately to insure that the phase is adjusted correctly for the primary hues.
12. Select a hue and readjust the chroma
13. Turn up the clip level control slowly to the desired level. Turn the soft/hard control knob counter-clockwise to the desired level. At this point, turning the pedestal knob clockwise slightly will compensate for the darkening of the colors after the clip level was adjusted. Select the input for channel 2 and repeat steps 7-8 and 12-13. Do not readjust the master phase on the output amplifier.

Working with the Colorizer

It is advisable to slowly try all of the variations in combining Channels 1 and 2 before adding more inputs to the system.

Switch between positive and negative inputs for each channel.

Set Channel One's clip select switch to "Ch 2" and then Channel Two's clip select switch to "Ch 1"

Readjust pedestal, clip levels and edge softness in each channel

Cross-Fades and Slow Control Voltage:

Try slowly-varying control voltages applied to the above parameters. For example, use the same oscillator and patch the positive sine out into the VC gain input of Channel 1 and the negative sine out into the VC input of Channel 2 with both clip levels set to the far left. This will result in a cross-fade between the two images. Try the same thing into the VC clip level inputs of Channels 1 and 2, the hard/soft inputs and various combinations of RGB inputs. For clip, gain and pedestal controls, patch the VC input into an attenuator first because none of the inputs has built-in attenuators. For RGB modulation, patch the negative output of an oscillator into one of the R,G, or B gain inputs and the positive output of the same oscillator into a second one of the R, G or B inputs. The control voltages can be unattenuated.

Quantization

The colorizer can be used to mix different inputs or to assign different colors to different gray level areas of a single input. This technique is called quantizing. It is done by selecting the same signal for several channel inputs. Using an image with a wide range of gray levels, the clip levels of each channel must be adjusted so as to not cancel one another out when selecting gray level areas to be colorized.

Control Voltages Above 60 Hz:

Even more complex graphic combinations can be accomplished by applying control signals above 60 Hz to the CV inputs of the clip level and pedestal. The colorizer is designed to take control voltages with frequencies that are several multiples of horizontal sync.

Complementary Colors

The VCAs of each channel will pass color. Changing the polarity of the signal will give complementary colors which can further be colorized.

Color Signal as Clip Input

It is best not to have a color signal going into the clip inputs. If you want to use the same signal as the clip input, put the color signal directly into the desired channel. At the matrix, route the same signal into the color kill and then into a separate channel of the colorizer. Use this color kill output as the clip input for your channels.

For Additive Mixing of the Channel Outputs

Set the chroma switch to the front. Turn the pedestals on all channels clockwise, even if you are only using the outputs of one or two channels. If you don't, nothing will be presented to the output.

B. PAIK/ABE COLORIZER



The Paik Abe input structure allows manual mixing of up to 7 video signals. The mix is applied to the three inputs of a color encoder, then passed through an output amplifier.

Panel controls for each input channel include a gain pot, an on/off switch and color mixing controls. The color mixing controls direct the video into one or two of the encoder inputs. Channels with selector knobs allow a choice of input to one encoder input or a pan into two inputs. Starting counter-clockwise the choices are Red, Green, Blue, R-G, R-B, G-B. On certain Paik Abe colorizers there are only five choices, with one of the mix choices omitted. However, all combinations are available using all three switchable channels.

It is important to note that these color designations are all relative to the HUE control on the output amplifier and will only hold relative relationships to each other. That is why the panel is not marked according to color.

The pan pot allows the signal to be panned into the two selected encoder inputs. Naturally if the selector is set to a one-input position, first three, then the pan pot is non-functional. On channels without a selector switch, a fixed pan selection has been made.

The Paik Abe does an additive mix, combining signals such that all portions of each signal reach the output. The images appear on top of each other, or superimposed. That is why the Paik Abe is sometimes referred to as a mixer. The inputs are sensitive, and a wide range of effects is obtained with a sweep of the input gain control. Sometimes a signal with enough gain will become negative. Key-like effects may appear. To get a feel for the machine, use all the knobs and go slowly.

There are no voltage control inputs on the Paik Abe. It is a manual device. However inputs can first be passed through video VCAs and the output can be processed through other voltage controlled processors in the system.

V. SEG

An SEG is a multi-input signal processor, usually incorporating different types of processes such as mixing, keying, wiping and switching. The Panasonic SEG in the system allows you to choose one of these techniques to combine two of its inputs at a time.

Three separate main inputs and an external key input can be

selected at the matrix. The 3 main inputs are each split and routed into 3 separate buses, A and B and a preview bus. Most of the operations allow a transition between A and B. The same inputs can be used on either bus. Vertical interval switching is used on images within a bus.

The transitions are Mix, Wipe, Int and Ext pushbutton controls.

MIX The SEG additively mixes the outputs of A and B. The bar manually controls the gains of the 2 bus outputs. It separates into two individually controlled levers to control the gains. When used together the bar will increase and decrease the gain of the 2 bus outputs proportionately. A vertical motion of the bar results in a crossfade.

WIPE A split-screen is used to divide the outputs of A and B. There are 6 selections for shapes to divide the screen: vertical, horizontal and corner inserts. When separated, the bar can individually control horizontal and vertical positions in a corner insert. Together they will wipe from A to B.

INT In the Int Key mode, the SEG acts like a two-input keyer. The output of B is the clip signal. There is no key reverse.

EXT In the Ext Key mode, the SEG acts like a 3 input keyer. Whatever signal is input to the Ext Key input on the matrix is the clip signal between the output of bus A and bus B.

In both key modes the bar is not active.

The third or preview bus has the same choice of inputs as bus A and B. When using Cut, the SEG will switch from composite out of bus A and B to the output of the preview bus.

When the SUP button is depressed, any signal patched into this input on the back panel of the SEG will be mixed with the composite output from the SEG. This is usually pre-patched so that the program out of the Character Generator is sent to it, to allow superimposition of text and image.

On each bus, color bars and black are provided on inputs 5 and 6 respectively.

Because the SEG contains the sync generator, signals sent to the genlock input are automatically accessed at input 4 of each bus, and on the matrix.

If signals are patched to inputs 4 and 6 on the back panel of the SEG, these input signals will override the genlock and black inputs respectively to the buses. If a signal is patched to input 5 of the SEG, a switch on the front panel below pushbutton 5 on the preview bus will switch between color bars and that incoming video signal, when 5 is selected on a bus.

The output to the SEG is sent to 2 separate points in the system, one in the matrix and one to the patch panel. Usually the signal is routed at the matrix. An output is also provided at the patch panel.

-To send color bars directly to the monitors and VTR without phase alteration from the output amp

-To use one of the color monitors as a preview monitor

-To use as an alternate output amp, using the SEG as the final destination on the matrix and bypassing the Jones output amp.

VI. Jones Buffer

The Jones Buffer is a black and white image buffer, which operates as a self-contained unit or in conjunction with the computer. The controls on the front panel are operative in the stand-alone mode. This allows for real-time digitization of the incoming signal, the ability to grab or store a single page, and a method of selective storage which uses a keyer-like function to select a clip edge between the real-time image and a stored portion of that signal. With computer control, software written on the Z-80 system allows the storage and playback of 16 pages of images. Variations in storing and playing back pages are made by using the analog and digital inputs on the D+7A interface. This method of frame animation can be used in conjunction with the selective storage capability.

The memory section has 128,000 bytes which can be divided in different ways. If the resolution is 256 pixels per horizontal line by 256 horizontal lines, there are 16 pages of memory. Each page can store one image. The images stored as pages are derived from the digitized video input.

By a process called selective storage, the buffer can grab a single whole image or selective sections of an image. Using a second video input image as a reference, a keyer-like device determines what part of the image, in terms of gray levels, will be up-dated with new information to be stored and what part will remain from the last storage process. Using the computer, you can also write on top of the stored information or create and paint new images.

Only one page of memory is viewed or accessed at a time. When the page is accessed, you are either reading the image or writing on what is already there. By grabbing and storing separate images, one in each page of memory, you can then read each page back in a sequence, creating animation.

The output of the buffer is a digital signal which is converted to an analog signal. This signal then can be further processed using other imaging techniques before it is recorded or displayed.

In either mode, the video signals are routed to and from the buffer on the matrix. There are 2 inputs, a video signal input and a clip input. There is one output.

When using the Jones buffer in the stand-alone mode, programs like STROBE64 and TESPNEW can be used. The Jones Buffer can be used with the CAT buffer, and both routed through the matrix.

When the Jones is in computer control mode, you must use programs written only for this buffer, for example NEWGRAB. This occupies the Z80 computer and D+7A box so the CAT cannot be used.

VII.

3M Character Generator Operating Instructions

Please read these operating instructions before using the character generator. For more information, please see the "Character Generator" section of the ETC Studio Manual.

Description

This is a black and white character generator. By itself, this unit has 16 pages of memory, numbered 0 - 15. As a stand alone unit there is no way to store these 16 pages. When you turn off the machine, all the text you have entered is erased.

There are 22 character spaces on each line. There are 10 lines on each page. There are 16 pages in the stand-alone unit.

There are two FONTS.

FONT ONE large and small capital letters

FONT TWO upper and lower case letters

You cannot mix fonts on the same page or on successive pages. Decide which font you want to use before you begin to enter any text.

You can make entire words FLASH on and off at a fixed rate. You cannot vary the rate of flash. You cannot flash a single letter within a word.

You can automatically CENTER each line of text.

You can ROLL through all 16 pages of text. Roll has three speeds. You can make the roll repeat.

You can CRAWL through all 16 pages of text one line at a time. Crawl also has three speeds as well as three positions of the single line. Crawl will also repeat.

With TITLE you can manually step through one line or two lines of the text on all 16 pages. Title also has three positions.

The characters can be displayed with SHADOWS by

To Turn On

1. Make sure that all the MODE SWITCHES, the rocker switches at the upper right of the keyboard are all DOWN, or in the normal position.

2. Make sure that the LCL/REM switch on the back panel is in the LCL or Local position. REM is used only with the memory unit.
3. Turn the power switch on the back panel ON. .
4. Press down the BREAK key and then the HOME key, in this order. This device will not operate properly if you don't.

To Select and Write on a Page

This is a two channel device. One channel allows you to write on that page: this is the PREVIEW channel. The PREVIEW channel has a grid overlaid on the screen to make it easier to compose the page. The other channel allows you to see what that page will look like: this is the PROGRAM channel. There is a display on the upper left of the keyboard which tells you which channels are selected.

To select a page on either the Preview or the Program channels, you MUST use a two digit number. If you want to write on the first page, that number is 00. The next page is 01 and so on to 15.

To select the PREVIEW channel: Hold down the CONTROL or CTRL key on the left side of the keyboard, and then the number of the page you wish to write.

To select the PROGRAM channel: Hold down the CTRL key and the SHIFT key at the same time, and then the page number you wish to view.

You can Preview one page and Program a different page.

If you see a COLON between the display numbers, the select function is incomplete. You probably did not enter the page number with two digits. Be sure the colon is OFF before continuing.

To Enter Text

1. On the PREVIEW channel, select the page you wish to write on. If you wish to see that same channel, then also select that page on the PROGRAM channel.

2. To ERASE the page before entering your text: HOLD down the ERASE PAGE key, a red key on the right side of the keyboard. There is a built-in delay to prevent accidental erasure, so the key must be held down for about 2 seconds.

3. Make sure you have selected the FONT type you wish to use for all the pages. Remember, you cannot change font types either on a single page, or on different pages.

4. Be sure that all MODE SWITCHES are DOWN, and that TITLE, ROLL and CRAWL switches are in NORM position.

5. The SHIFT key, on the left side of the keyboard, lets you use the characters on the upper position of those keys, mostly numbers, with two rows of characters.

6. The SMALL LC/LARGE UC key lets you select either large size or small size letters within the font type you have chosen. If this key is in the normal or up position, the characters are LARGE. If the key is depressed, the characters are SMALL.

This key also selects the right column of characters on those keys with more than one character.

If SHIFT is up with LARGE UC, then lower left character is selected. If SHIFT is up with SMALL LC, then lower right character is selected.

If SHIFT is down with LARGE UC, then upper left character is selected. If SHIFT is down with SMALL LC, then upper right character is selected.

7. Enter text. Each letter will be entered where the cursor is positioned. To MOVE THE CURSOR, use the keys with arrows. HOME places the cursor in the upper left of the page. Return followed by LF will move the cursor to the left margin of the next line down. If you intend the text to be crawled, you need not worry if the word breaks between lines. Type as you normally would. If you intend the text to be rolled, you must be sure that a word is not broken between two lines.

If you make a mistake, retype over the mistake.

When you get to the end of the page, stop typing. Select the next PREVIEW page you wish to fill with text and continue. The device will not automatically go on to the next page.

8. To make a word FLASH, select LARGE UC function and press the FLASH key before the beginning of the word you want to flash. All characters from that point to an empty space or the end of the line will flash.

9. To cause the text to be rolled or crawled to a certain point and then either stopped or repeated: Use the RM {RECORD MARK} function. At the place where you want the roll or crawl to stop, use the SMALL LC function and hit RM. This places a rectangle on the Preview screen which notes where the roll or crawl will stop. You will not see the rectangle on the program screen.

10. To CENTER, first move the cursor to the far left position on the line you wish to center and then hold down the AUTO CTR key. This will center the text on the line where the cursor is located. This works on a line by line basis.

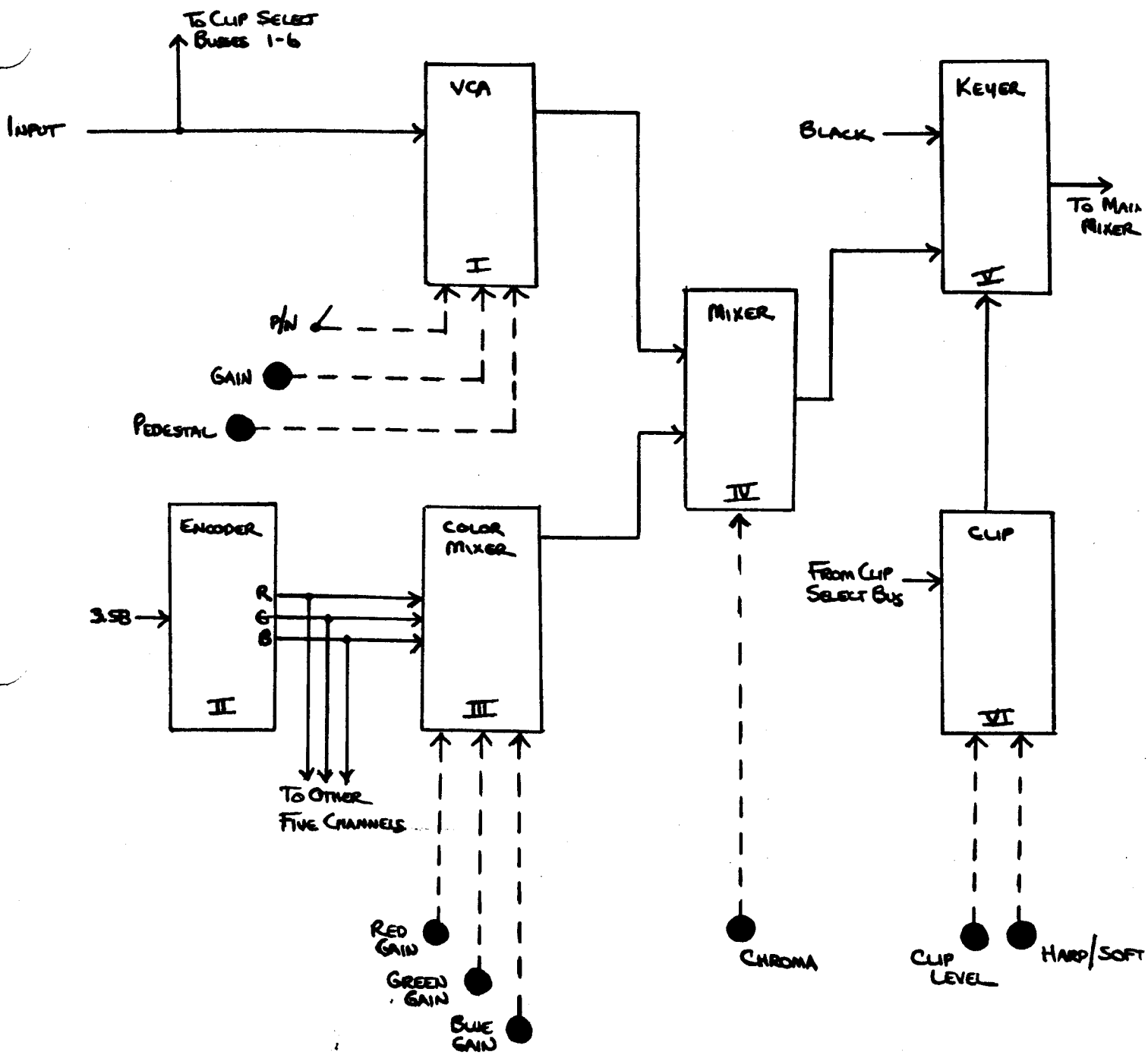
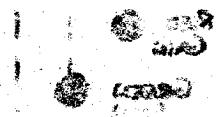
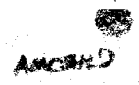
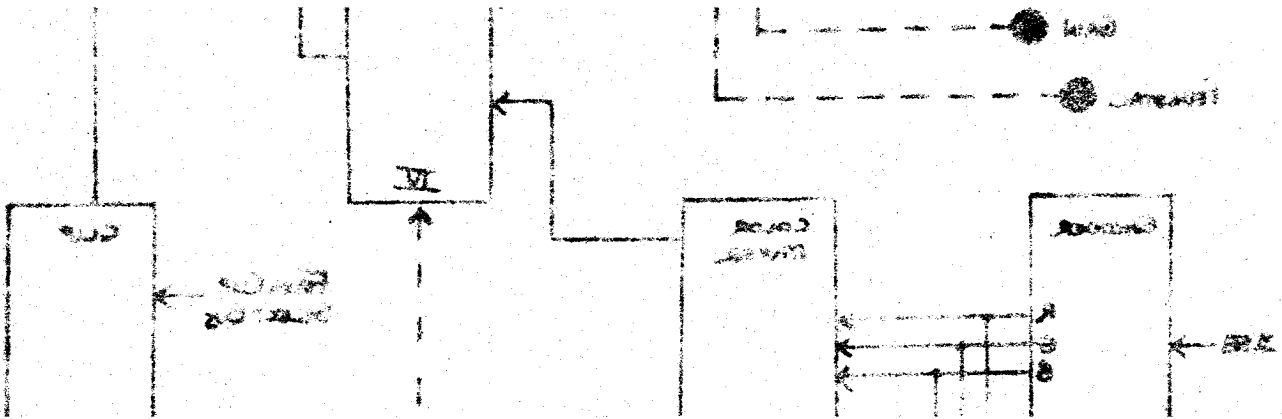

FIGURE 1 COLORIZER CHANNEL



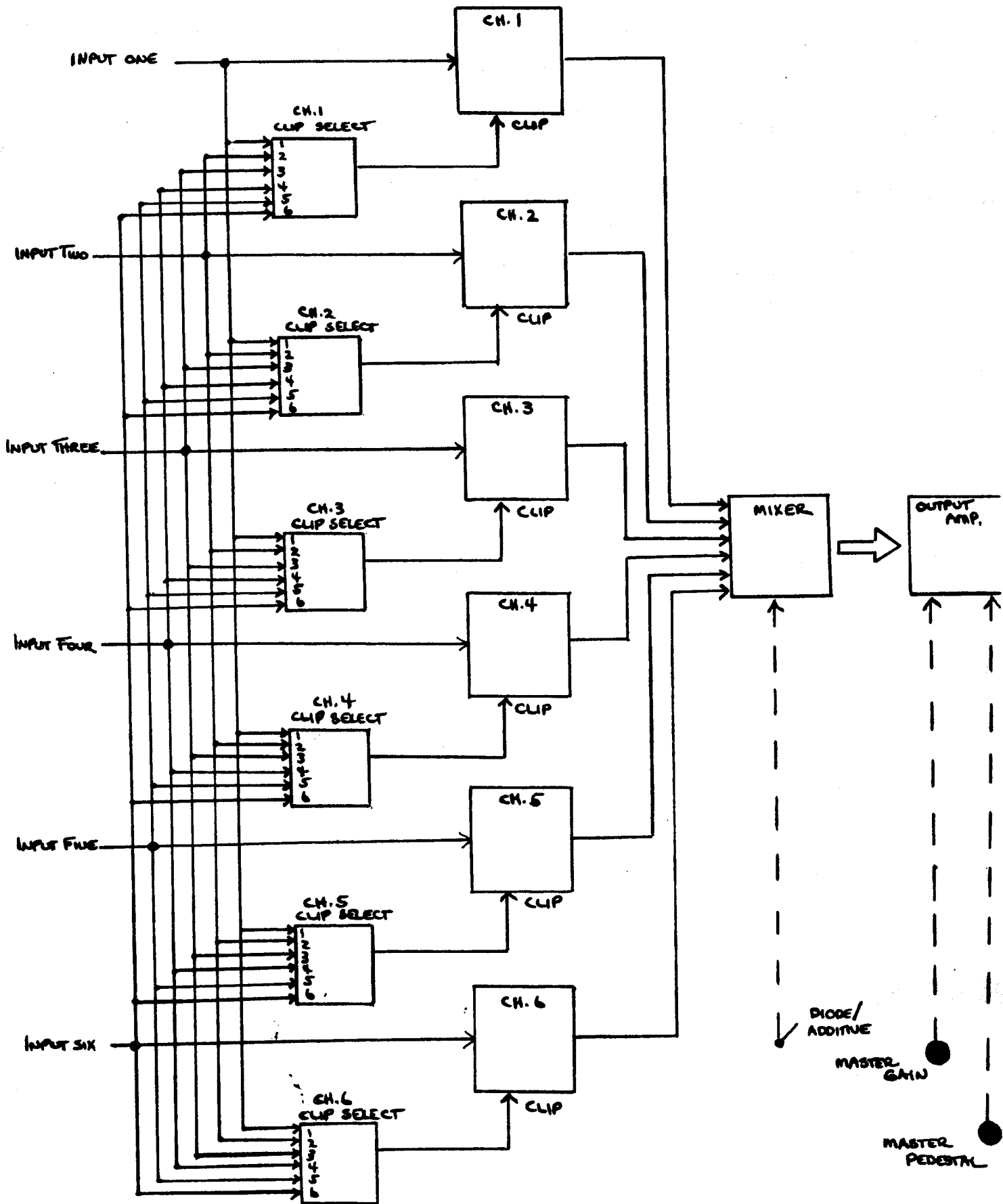
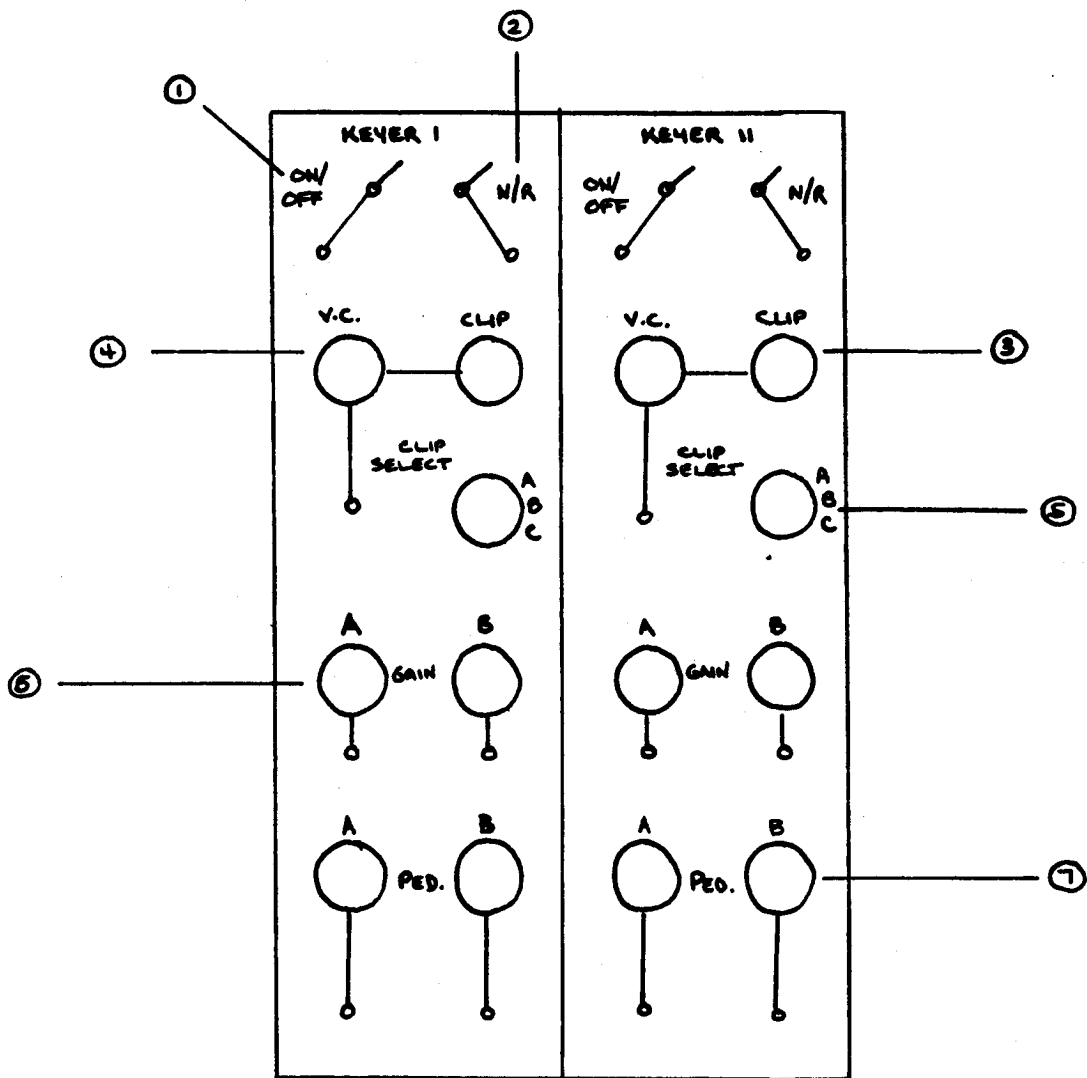

FIGURE 2

CLIP SELECT SYSTEM

COLORIZER



1. On/Off switch: use or by-pass the clip
2. Normal/Reverse switch: type of keying
3. Clip level control
4. Voltage control input and range adjustment for clip
5. Three-position clip select switch
6. Gain controls for Channels A and B
7. Pedestal controls for Channels A and B

Jones Keyer Front Panel

Figure 1

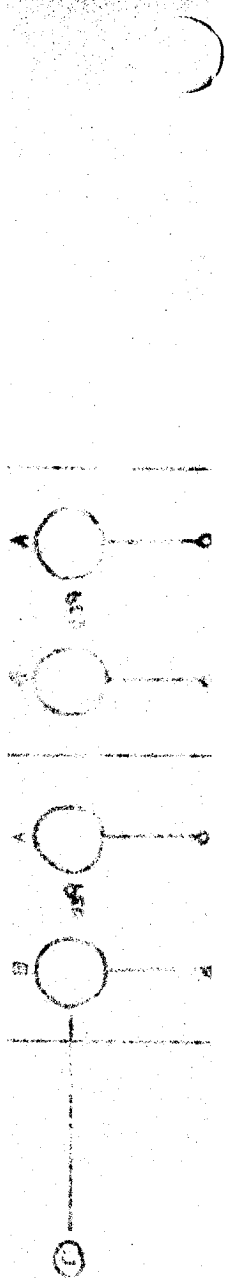

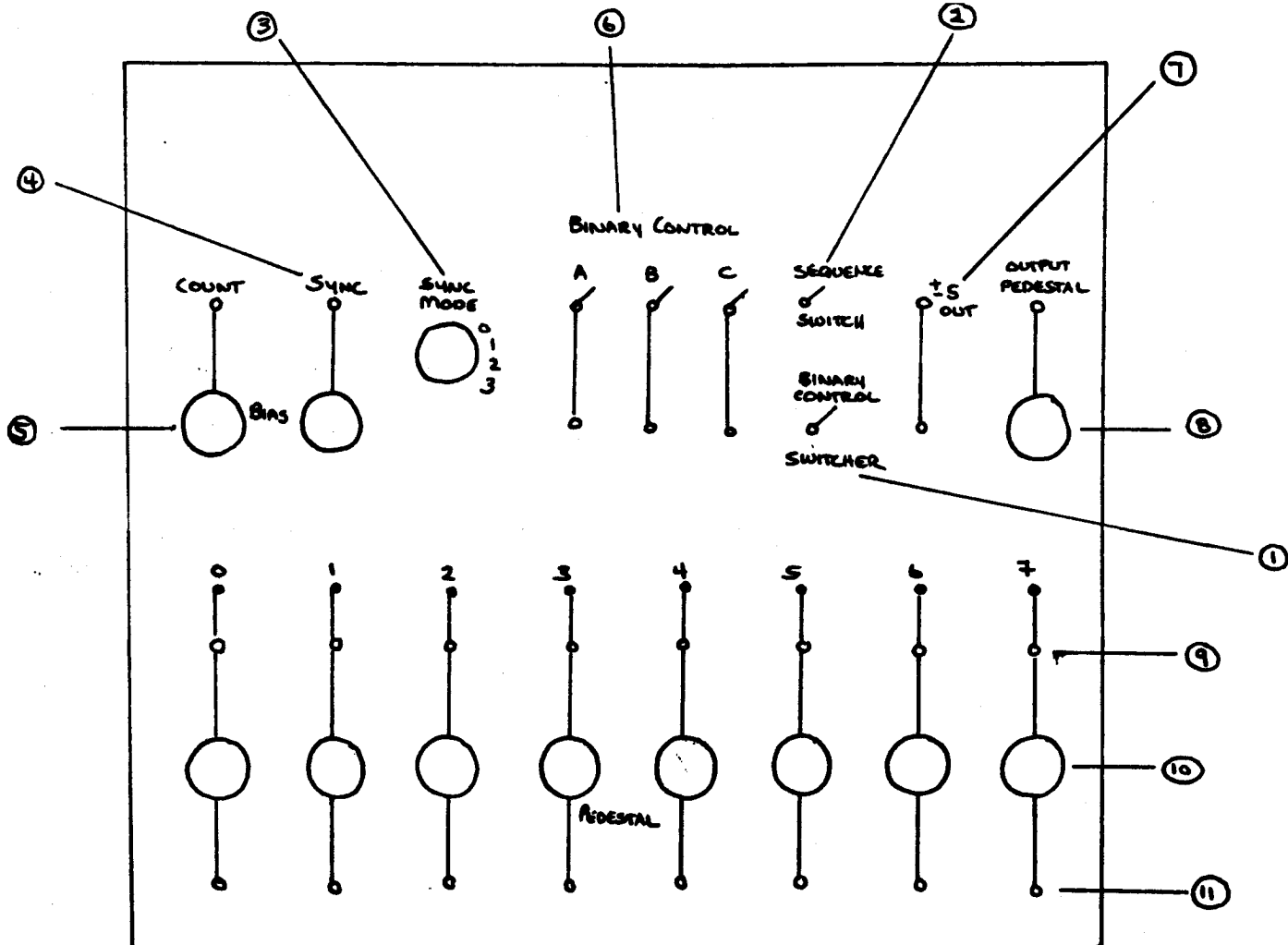
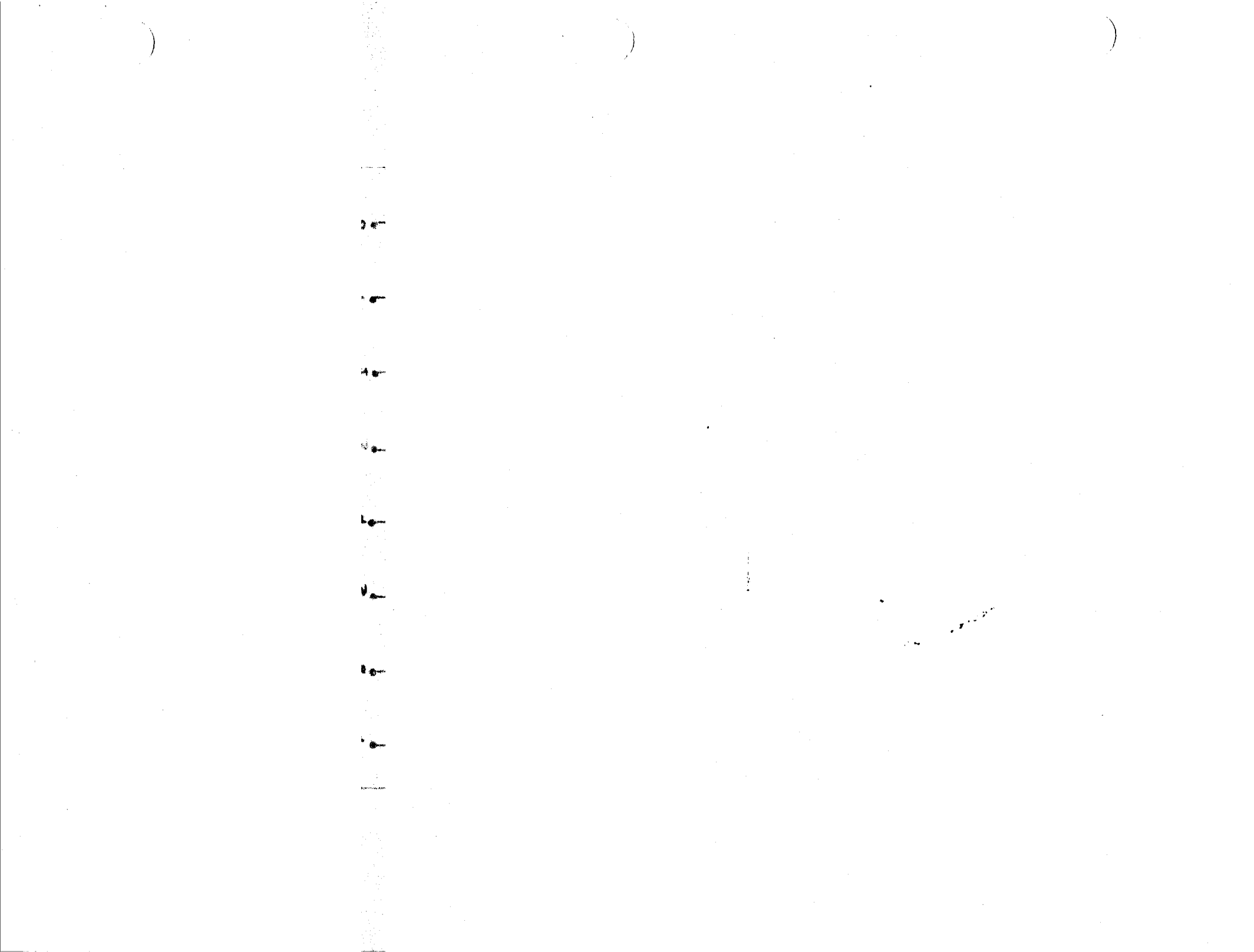

FIGURE 1 SEQUENCER FRONT PANEL

- (1) Two-position switch for selecting mode of switch. "Binary" is up. "Switcher" is down.
- (2) Two-position switch for selecting sequence or switch. "Sequence" is up. "Switch" is down. When down, the binary or switcher positions on switch (1) operate.
- (3) Four-position sync mode select switch.
- (4) Sync input jack and bias control knob
- (5) "Count" or clock input jack and bias control knob
- (6) Binary control switches and associated control voltage input jacks. A is most significant bit. B is second most significant bit. C is least significant bit.
- (7) Two plus/minus 5 volt signal output jacks
- (8) Pedestal control knob and voltage control input jack for video output.
- (9) Pushbutton controls for manual switching between channels 0-7 in the "switcher" mode. Corresponding lights, LED indicators, are above.
- (10) Pedestal control knob for each channel. DC bias control for Plus/minus 5 volt output.
- (11) Voltage control input jacks for pedestal of each channel. Signal input jacks for plus/minus 5 volt sequencing.



A	B	C	Decimal
0 off	0 off	0 off	0
0 off	0 off	1 on	1
0 off	1 on	0 off	2
0 off	1 on	1 on	3
1 on	0 off	0 off	4
1 on	0 off	1 on	5
1 on	1 on	0 off	6
1 on	1 on	1 on	7

FIGURE 2

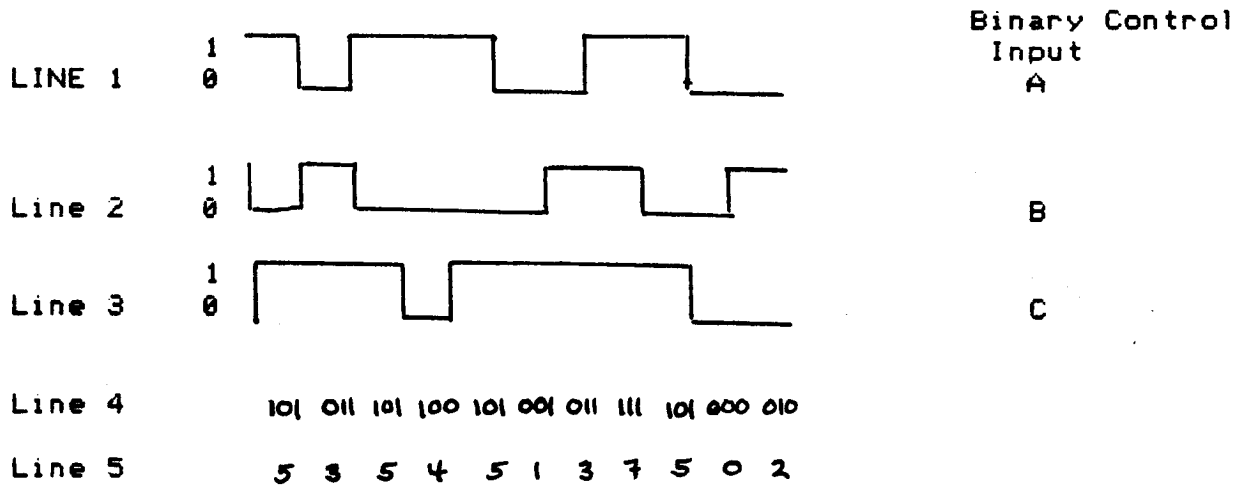

FIGURE 3

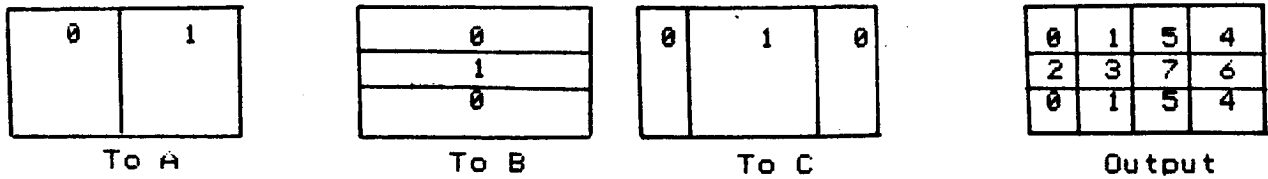

FIGURE 4

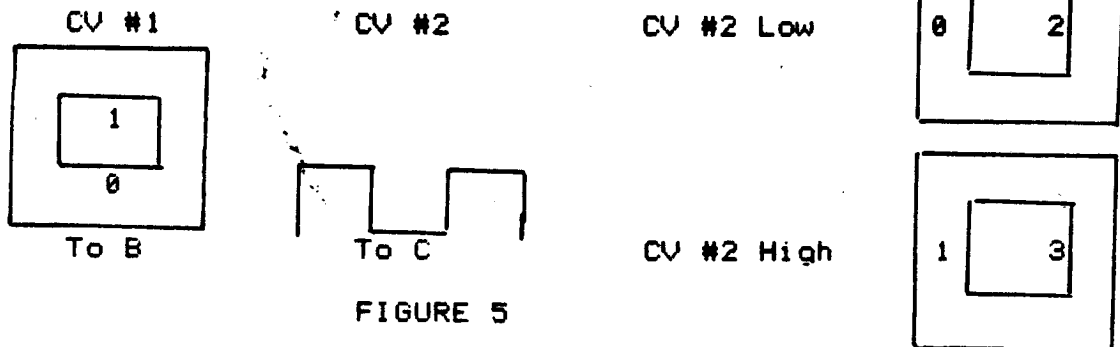

FIGURE 5

SEQUENCER

The Center's Analog Synthesizer is a modular system for creating different types of changing voltages. The final outputs of the Synthesizer will be used in two distinct ways:

- 1) as control signals for the image processing modules
- 2) as synthesized audio for sound tracks

The system has been designed specifically to produce slowly changing voltages suited to controlling various parameters on the imaging modules such as fading, keying, colorization and so on. One way to view the Analog synthesizer is as a machine that combines various simple changes (represented by changing voltages, which are usually periodic in nature) for the purpose of obtaining interesting and complex changes in imagery. Our model has been the modular electronic music synthesizer, and we have retained many specific standards from that industry. The Analog Synthesizer is compatible with most commercially made audio synthesis equipment, so you are encouraged to bring your own synthesizers to the studio if you wish. If you plan to do so, please check first with the Center's staff to be sure that the appropriate cables are available.

To use this machine you will have to think about voltage control. We can think of voltage as a quantity that can be measured discretely, for example a given number of volts, 5V. For this to be meaningful we need a point of reference. Usually ground (earth) potential is used as a reference as 0V. All sources of constant voltage (DC which stands for direct current) are signed. They have a positive and negative terminal, like a battery. If the negative terminal were connected to ground, then our 5V source will have +5V with respect to ground at its positive terminal. If the positive terminal were connected to ground instead, then we would have -5V at the negative terminal with respect to ground. In the Analog Synthesizer we use both polarities of voltage with respect to ground, and the term "bias" to describe this relationship.

Our control voltage standard is -5V to +5V. Both the Analog Synthesizer and the video image processing modules have been built to respond to this voltage range. This means that a certain aspect of a module's output will be varied from one useful extreme to the other by a sweep of -5V to +5V. This range can be expressed as 10V peak to peak, abbreviated as 10V P-p. For example: in controlling video pedestal, -5V at the control input would produce black while +5V would yield a white pedestal level, with values in between producing various grey levels. You will find that the useful range will lie somewhat within the -5V to +5V standard. So it will take less than 10V P-p (peak to peak) to sweep the effective range. Since the Analog Synthesizer puts out 10V P-p, it is a simple matter to reduce this voltage to the desired level.

Most of the control knobs on the video modules have

associated jacks for taking in control voltages. A changing control voltage applied to one of these jacks has the effect of "automatically" turning the knob. Advantages of using a control voltage instead of just turning the knob include (1) variations which are smoother or quicker than would be possible by hand, (2) increased precision and (3) step-like movement. Manual control is useful for complex changes.

There are three important aspects of a control voltage:

1. GAIN the total voltage excursion, expressed in volts peak to peak
2. BIAS the relative placement of the waveform relative to ground
3. WAVESHAPE the nature of change with respect to time

We represent these aspects graphically in the example below by plotting voltage (expressed along the Y axis) with respect to time (expressed along the X axis).

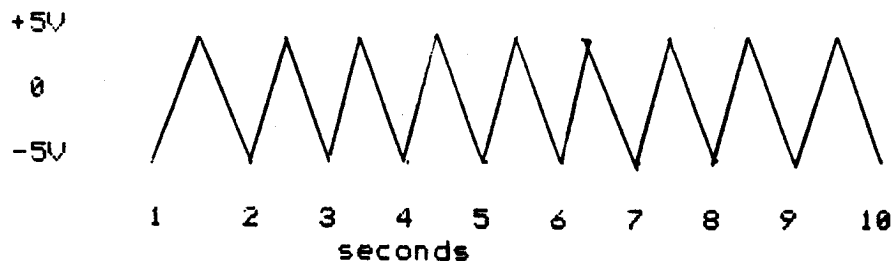

In this example, the GAIN is 10V P-p, the BIAS is centered at ground or 0V, and the WAVESHAPE is called triangle. The rate or FREQUENCY of this signal is 1 Hertz, expressed as 1 Hz. This means that the waveshape takes one second of time to complete its form and begin to repeat itself. A triangle waveform is called PERIODIC because it repeats itself on a regular basis within a given period of time. Hertz (Hz) refers to the number of cycles the waveform goes through in one second.

To illustrate how such a control signal can be used in the video synthesizer, let's take this example signal and look at how the patch would be set up.

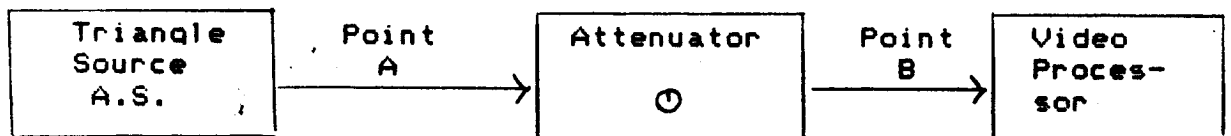

Signal at Point B:

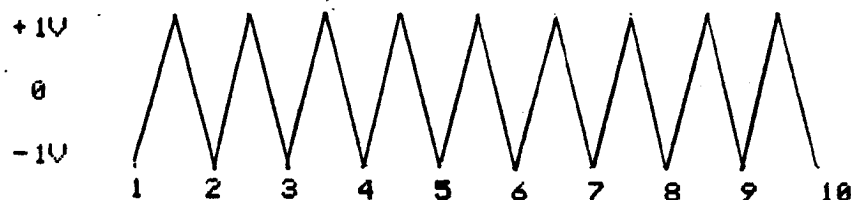

The attenuator, which means reducer, is simply a potentiometer (pot) or knob that enables us to lower the gain of a signal with respect to ground. An ordinary volume control is an application of this type of device. In the patch, Point A is the example signal from the Analog Synthesizer. This is patched to the input of the attenuator. Depending on the knob setting, we can obtain any peak to peak value less than 10V P-p at the output of the attenuator. The graph "Signal at Point B" shows the attenuator output, arbitrarily selected to be 2V P-p. This is the signal we will apply to a control input on a video module. Here we must examine how the control knob on the video module interacts with the incoming control signal.

The first point to understand is that the knob is also a source of a control voltage. If there is no input to the VC input jack, then the knob voltage is the only one used. When a voltage is applied to the VC input, it is mixed with the knob voltage. Since it is the nature of our mixers to invert (change the sign) of the incoming voltage, the knobs have been made so that counter-clockwise represents +5V and clockwise represents -5V. This is so that after the mixer, the voltage will be positive for clockwise-of-center rotations. Thus turning the knob clockwise results in black to white, low to high and so on. This also means that, with the knob centered at 0V, a control input of +5V is the same as having the knob all the way counter-clockwise with no control input. You must think of a falling (negative going) control signal as producing the effect of turning the knob clockwise.

Below is a graph of the voltage output from a knob. The following graph represents an inverted mix of this knob voltage and our attenuated control signal. You can see how the relative placement of the control signal is moved by the knob. This is called BIASING the signal.

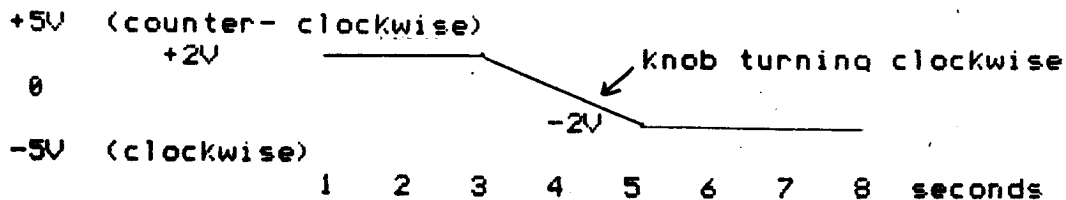

Let's continue to analyze how the attenuator and bias knobs allow us to get the effect we want. As an example, let's control the clip of a Keyer. With no control voltage input, the extremes that we wish are at these knob settings: \odot and \ominus which are about one-third of the total knob rotation. From this we can

guess that we will need about 3 or 4 volts P-pk to get the entire sweep we require. As long as we start with a larger signal, the attenuator will allow us to achieve the proper gain. With the signal applied to the VC input, the control knob can now be used to bias the signal so that the start point and end point of the effect are where we want them. At this point it is a matter of adjusting the knobs while observing the image in order to set up the desired effect.

Now we will look at the different types of signals in the Analog Synthesizer. A signal can most generally be defined as a voltage that changes with respect to time. In the Analog Synthesizer we can think of a "signal" as the changing voltage of an oscillator that we are going to process and use as an input to video image processing modules. The terms signal and control signal are relative and refer only to use. In general, a control is lower in frequency than the signal it is modifying.

In the Analog Synthesizer signals are classified according to bias, function and waveshape.

BIAS

1) +- Signal This type of signal usually remains within +-5V. However if several of these are added in a mixer, the total possible range is about +-12V. This is the maximum voltage excursion in the Analog Synthesizer.

2) + Signal This type never goes negative and usually stays in the 0 to +5V range. Certain modules output this type of signal, and if a negative signal is presented at their inputs it will not pass through. The output will hold at 0V.

FUNCTION

1) PULSE This is sometimes called TRIGGER. It is a short positive voltage excursion from 0 to +10V and back. It is the point in time that the voltage jumps high that is significant. This point may be used to determine the start of other events in the system.

2) GATE A signal which is either 0V or +5V. 0V signifies OFF while +5V signifies ON. This acts like a switch to control the duration of an event, or how long it goes on.

WAVESHAPE

Signals classified according to waveshape are named for their graphic representations. See the following page. These periodic waveforms repeat. The number of periods in one second is the frequency in Hertz. The terms positive and negative ramp refer to direction of change, not to bias. Note that inverting (turning upside-down) a ramp or pulse changes the shape, while inverting a triangle, sine or square does not.

These are commonly used waveforms. The YX axis represents voltage. The XY axis represents time.

POSITIVE RAMP

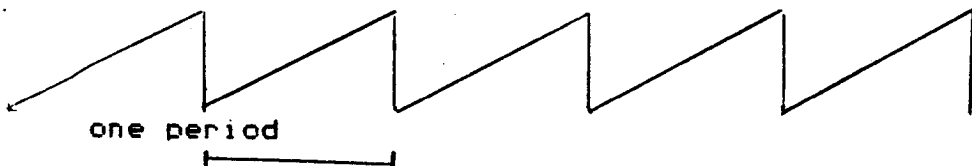

NEGATIVE RAMP

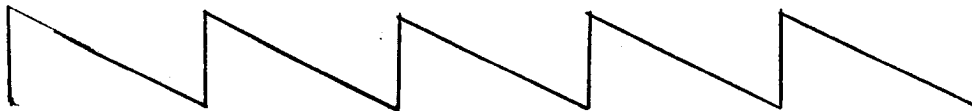

TRIANGLE



SINE



SQUARE



PULSE



CONVEX POSITIVE RAMP



CONCAVE POSITIVE RAMP



What happens if the pulse output is patched to the input?
When the connection is made the rail output
rises quickly following the raised input voltage, but as soon as

DETAILED MODULE DESCRIPTION

The Analog Synthesizer has two boxes each with its own set of modules. The panel controls are listed first and then the functions are described. Module panels have the following features: 1) Signal inputs 2) control inputs 3) one or more outputs 4) knobs for setting initial points (bias knobs) 5) knobs for inverting or attenuating control voltages and 6) special devices such as switches or lights. Inputs are generally to the left and top while outputs are to the right and bottom. Black lines between jacks indicate internal electrical connections.

NEGATIVE RAMP

RATE	Bias pot setting initial rate of fall
VC	Attenuator/inverter pot with control voltage input
IN	Main signal input
OUT	Main signal output
P	Pulse Output
LAMP	Output level indicator

The function of this module is to limit the rate at which the output can follow as the input voltage falls. This rate is initially set by the RATE bias control, with more clockwise settings corresponding to higher rates. The rate may also be varied by a control voltage applied at VC. The knob above VC attenuates and/or inverts the control voltage in this manner. At the center of its rotation, an incoming control voltage will be most greatly attenuated, that is will have the least effect. Turning the knob to the right, clockwise, will cause a positive voltage being presented at the VC input to effect a higher rate. Counter-clockwise rotation with a positive VC input will lower the rate. The farther the knob is turned in either direction, the greater the effect. Negative voltages may be applied to the VC input.

The negative ramp module puts out only positive voltages, thus the input must be positive to pass through. There are two outputs. The main signal output will accurately follow a rising voltage at the input, while limiting the rate of a falling input. The pulse output remains at +10V while the main output is close to 0V. If the main output rises above about .2V, the pulse output will go 0V. The lamp indicates main output voltage, getting brighter as the main output increases in voltage. If the output frequency is rapid, the light will appear to remain constant at a medium brightness.

What happens if the pulse output is patched to the main signal input? First, the output has been at 0, so the pulse output is high, +10V. When the connection is made the main output rises quickly following the rising input voltage, but as soon as

the main output rises this causes the pulse output to go to 0V. Since the main output can't fall any faster than the control will allow, we will get a falling ramp at the main output. When the ramp approaches 0V, the pulse output jumps high and the process is repeated. Thus we have an oscillator with ramp and pulse outputs.

When patched as above, the two negative ramp modules on the Analog Synthesizer each have different frequency ranges. These are shown below.

MODULE	RANGE	with CONTROL VOLTAGE
Top Negative Ramp	38 sec/cycle to 500 Hz	up to 1200 Hz
Bottom Neg. Ramp	17 sec/cycle to 1000 Hz	up to 2500 Hz
Top Positive Ramp	23 sec/cycle to 1000 Hz	up to 1700 Hz
Bottom Pos. Ramp	7 sec/cycle to 2000 Hz	up to 4000 Hz
Top Triangle	120 sec/cycle to 1700 Hz	
Bottom Triangle	90 sec/cycle to 2000 Hz	

POSITIVE RAMP

RATE	Bias pot setting initial rate of rise
VC	Attenuator/invertor pot with control voltage input
IN	Main signal input
OUT	Main signal output (TOP)
P1	Pulse output one
P2	Pulse output two
START	Input for starting ramp
SUS	Input for starting ramp and sustaining at +5V
Switch	Performs gate function for sustain
VC	Voltage control of waveshape from lower output
OUT	Sine type waveform output (BOTTOM)

The function of this module is to limit the rate at which the output can follow as the input voltage rises. This rate is controlled in a manner similar to the negative ramp. There are four outputs. The main signal output limits the rate of a rising input, while accurately following a falling input. P1 is low while the ramp is above 4.5V and goes high at the point the ramp wave falls. There must be an input to Start or Sus to get an output from P2. P2 stays high while the ramp is rising and holds at 0V if the main output is also at 0V. For both pulse outputs high equals +5V. Like the negative ramp, an oscillator can be patched by connecting P1 to IN. The resulting ramp wave at the main output is about 4V P-p from +.5V to +4.5V. A sine-type waveform is simultaneously available at the lower output, and its shape is voltage controllable. This output is also positively biased and has a gain of about 2V P-p.

An oscillator can also be created by patching P1 to Start or Sus. This will give an output at P2 as well as raising the main signal output gain to 5V P-p.

A rising ramp may be started by supplying a trigger pulse to the Start input. When this ramp is completed and returns to 0V, it will remain at 0V until another trigger is received. A trigger applied to Sustain will also start a ramp. If a gate is applied to Sustain, a ramp will be initiated also, and if the gate is still present when the ramp has reached its maximum, the main output will hold at +5.5V until the gate is removed. A gate patched to Start will perform the starting function, but will not sustain the output.

P1 Patched to Sustain

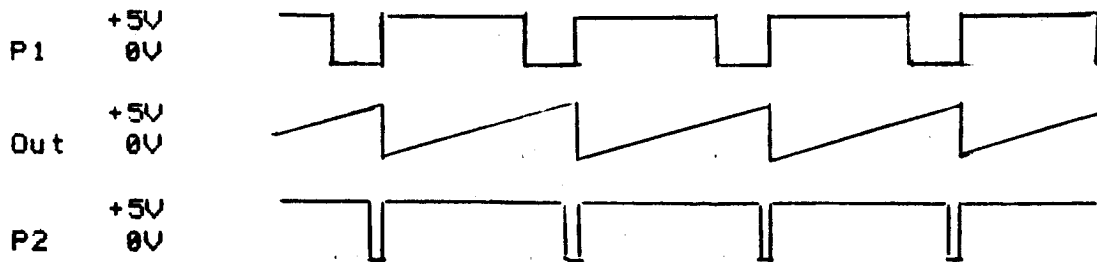

External Pulse Patched to Sustain

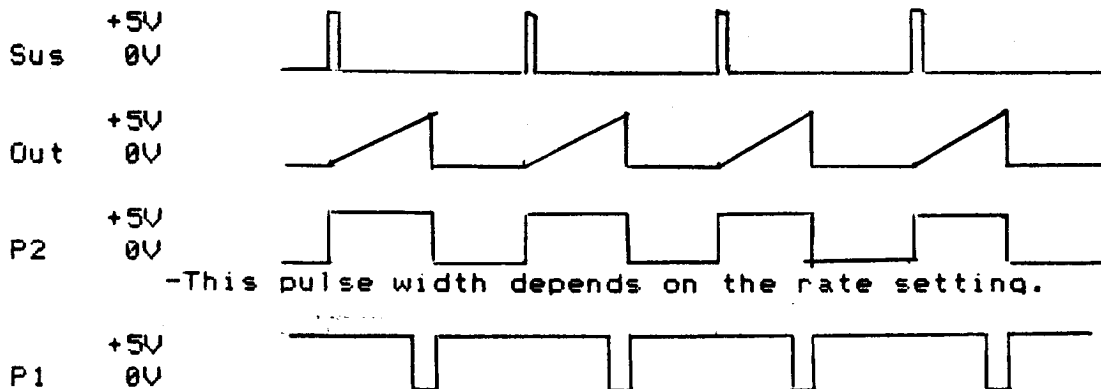

WAVESHAPER (WS)

GAIN	Input attenuator
SHAPE	Bias pot setting initial waveshape
VC	Control voltage input #1
VC	Control voltage input #2
IN	Main signal input
OUT	Main signal output

The purpose of this module is normally to convert a positive ramp wave into a sine-type wave with a voltage controllable waveshape. For proper operation in this mode the input should be a positively biased positive ramp wave (such as the output of a positive ramp) with a gain of about 2V P-p. An input attenuator is provided for setting this gain.

The shape control is a bias pot which sets the initial waveshape. Centered, the output is an approximate sine wave. Varying the control results in a more ramp-like waveform at the output. The extremes of rotation produce nearly concave positive or negative ramps. The output is positively biased with a gain of about 5V P-p.

The VC input directly below the shape control allows voltage control similar to the shape control pot. With the pot centered, $\pm 5V$ is sufficient to sweep the pot range. The lower VC input has the effect of biasing the output so as to cut off the lower portion of the signal, which also changes the waveshape.

Other waveforms may be applied to the input. Note that at audio frequencies the WS is used as a timbre modifier.

INVERTER X2

This module, which has no controls, is designed to convert a 0 to +5V signal to a $\pm 5V$ signal. Since it also inverts, the in/out relationship looks like this:

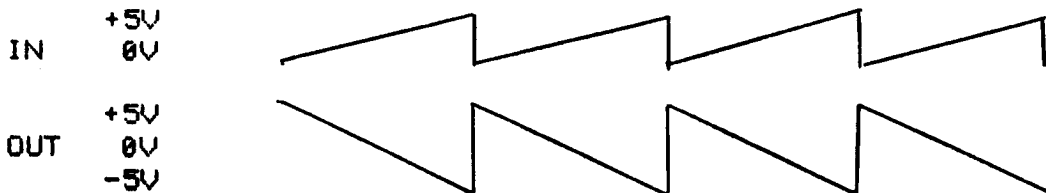

You can see that an input of 0V (no input) will leave the output at +5V. +2.5V in comes out 0V. +5V in comes out -5V. The gain is doubled. A hint: If you want to invert but leave the output still at 0V to +5V, simply attenuate the input to 2.5V. Note that a negatively biased input will cause the output to go above +5V. This module is meant to increase the gain available from the Ramp modules. Since the output from the Triangle patched to oscillate is -1V to +4V, passing this signal through Invert X2 will give +7V to -3V out. This is still within a usable range.

RANDOM

- WHITE 1 White noise output with energy concentration in center
- WHITE 2 White noise output with energy concentration at edges
- PINK Pink noise output filtered from WHITE 1
- RAMP + Fast random ramp output, positive bias, 5V P-p
- RAMP +- Fast random output, +-bias, 10 V P-p
- SAMPLE Button changes Step outputs to new random level
- SAMPLE Jack accepts trigger pulse input for above function
- STEP + Random held voltage output, + bias
- STEP +- Random held voltage output, +- bias
- TREM 7 Hz sinewave output with random amplitude

Q Varied randomness is TREM output
 PULSE Random pulse output
 RATE Varies range of random pulse frequency

The random module is a source of different kinds of randomly changing voltages. Random sources are categorized by their average rates of change. White noise contains the widest range of frequency variations: the entire audio range, 20 Hz to 20 KHz. Pink noise contains less high frequencies than white noise, while the random ramps are low in frequency. Patching these sources to an audio monitor will give you a good idea of this. The step outputs have a rate of change equal to the sample pulse rate.

White 1 output is biased about ground and is generally 5V P-p. The probability for an instantaneous output is higher for values nearer to ground. White 2 is 8V P-p biased at ground, with greater probability of an instantaneous output being at either + or -4V.

The Step outputs are from a sample-and-hold-connected internally to a random source. Pushing the button or supplying a pulse to Sample (the only input on the module) will set the Step outputs to new random levels. These voltages drift slightly.

Patching the random tremelo output to an oscillator VC input will quickly show how this functions. Notice a time lag after turning the Q knob before the effect changes.

The Rate control adjusts the random pulse output from a pulse every few seconds to dozens per second. When setting this control allows 15 seconds or so to observe the effect at one setting.

ONE SHOT

S Sample Input
 T Track input
 OUT One shot output

This module has no controls. Normally the output sits at +10V. If a trigger pulse is supplied to the S input, the output will fall to 0V for a preset time interval of about 1 ms, then rise quickly back to +10V. A gate to the T input will cause the output to hold at 0V as long as the gate is present.

Patching the output of this module to the Hold input of the Triangle module creates a sample and hold. During this patch, a gate to the Track input returns the Triangle to its following mode.

ONE PULSE

This module puts out one 100 uS pulse each time the button is pushed. Use this for a manual trigger.

GATE

This switch when up applies +6V to its output jack and 0V (ground) when down. Use this for a manual gate (patch to Hold, Track, Sustain, etc.).

In/Out Waveforms for One Shot

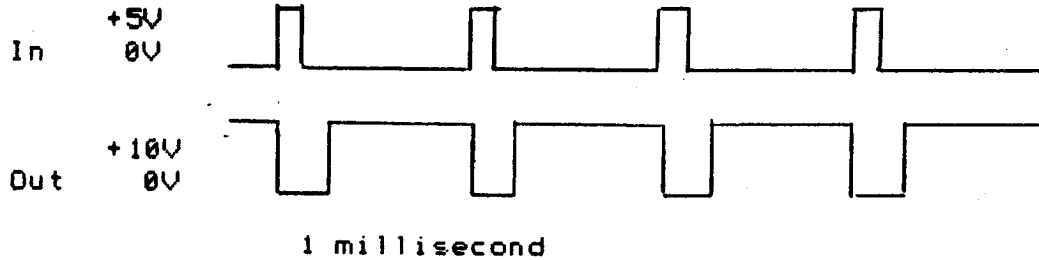

TRIANGLE

RATE	Bias pot setting initial triangle period
VC	Attenuator pot with control voltage input
IN	Main Signal input
OUT	Main signal output
P	Pulse output (+-11V, 22V P-p)
H	Hold input
Lamp	Output level indicator

The triangle module limits the rate at which the output can follow both rising and falling voltages at the input. Unlike the Ramp modules, the Triangle inputs and outputs may be biased positive or negative. The main and pulse outputs are related in this manner: as the main output falls below -1V, the pulse output goes to +11V and holds there until the main output rises above +4V. The pulse output then falls and holds at -11V until such time as the main output again falls under -1V. Patching the pulse output to IN yields an oscillator with the following waveforms:

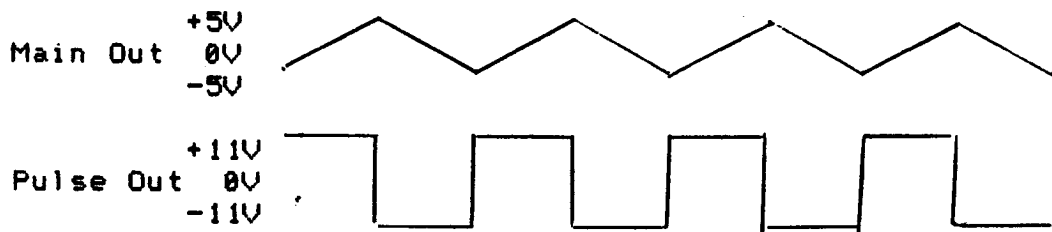

Another difference from the Ramp modules is that the VC attenuator pot does not invert an incoming control voltage; positive voltages always increase the rate.

The Hold input accepts a +5V or higher gate signal. When the gate is presented the main output will hold at the voltage it had at the moment the gate went high. This same function may also be accomplished by bringing the VC input to a sufficiently negative value, depending on the initial rate setting.

The lamp is an output level indicator which functions similarly to the lamp on the negative ramp module.

ANALOG SYSTEM: MODULES IN BOX 2

VOLTAGE CONTROLLED OSCILLATOR (VCO)

FREQ	Bias pot setting initial frequency, wide range
FINE	Bias pot setting initial frequency, narrow range
VC	Most sensitive control input, with attenuator
LIN	Least sensitive control input, inverted
IV/OCT	Control input set for 1 V increase to double frequency
HI/LO	Audio/subaudio range selector
H/EXT/V	Sync selector switch
EXT	Sync input
RAMP	Sawtooth waveform output
TRI	Triangle waveform output
SIN	Sine waveform output

This module is a music quality oscillator. Its function is to generate periodic waveforms of three shapes, the controlled parameter being the frequency of the outputs. There are a number of control inputs which may be used simultaneously. The outputs are all the same frequency and are all similarly affected by the controls. A HI/LO switch determines the mode of operation. HI mode is that of an audio range oscillator. LO mode is that of a very low frequency control oscillator.

In LO range the frequency is manually variable by the bias pots from 1 cycle every 20 seconds to about 15 Hz. In HI the manual range is 16 Hz to 16 KHz. Both of these ranges can be expanded with voltage control. Negative control voltage will lower the LO range infinitely until oscillation stops. Positive control voltage can extend the HI range up to 100 KHz, however at this frequency the outputs are degraded in amplitude and shape.

All FM (Frequency Modulation) inputs allow exponential control of the frequency. This means that for an increase of a set amount of voltage (for example, 1V) the frequency will be multiplied by some factor. In the case of the V per octave inputs, a 1V increase will double the frequency. The VC input with attenuator allows adjustment of this factor, and at high settings the frequency may be multiplied by a factor of 4 or more for each volt increase of control voltage. The LIN control input is much less sensitive, and operates inversely: an increase of control voltage lowers the frequency. This ratio is set at approximately 6V/octave.

Sync options are selected with the sync switch. Center is

off, while H/EXT normally supplies horizontal sync for use at high frequencies (above 15 KHz). Should a signal be patched to the EXT sync input, this input is selected instead of horizontal sync. Signals patched to EXT should have a sharply rising edge for proper syncing. The V position selects vertical sync. Standard video sync must be plugged to the BNC inputs at the left of the panel for these functions to be used.

All outputs are standard $\pm 5V$ signals. The phase (relative changes) of the outputs are shown below.

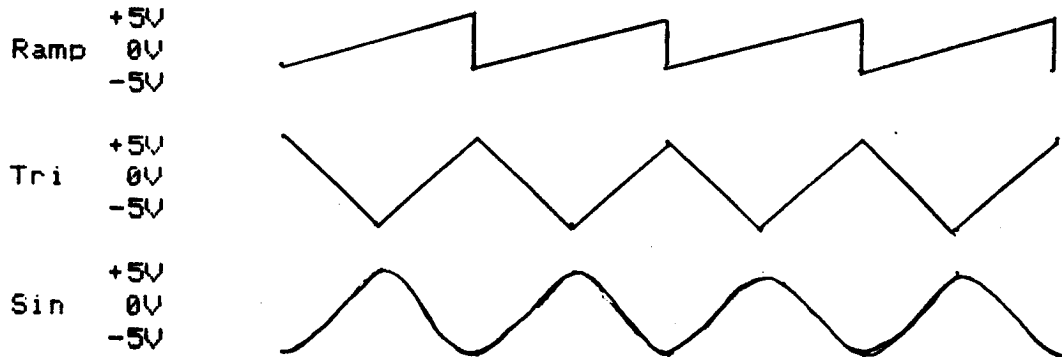

COMPARATORS

Under the heading of Comparators are three small modules above the Comparator modules. These will be described first.

1) Capacitor A patchable capacitor is available between the two jacks containing the symbol for capacitance (-11-). Either jack may be the input. Its function is to block the offset bias of an audio frequency signal, so that the output is rebiased around ground.

2) V and H Vertical and horizontal sync pulses are available at these jacks, pulses going from zero to +8V for system compatibility. Example: Start a ramp with a V pulse.

3) Invert A standard analog inverter is made available for changing the sign of the input voltage.

Comparator Panel

IN	Comparator input
OUT	Comparator output
VC	Control voltage input for reference
REF	Bias pot for setting initial reference point.

The function of the comparator is to compare two voltages and signal when one is higher than the other. The output is high (+8V) if the input is higher than the reference voltage, and zero volts if the input voltage is lower than the reference. Thus if a periodic voltage is applied to the input and regularly crosses the reference point, a pulse wave is the resulting output.

Since the duty cycle of the pulse wave is determined by the relative setting of the reference, this parameter is variable and may be voltage controlled. This is called pulse width modulation. The comparator may be used to obtain pulse or square waves from any oscillating module. Notice that a square wave is a special case of a pulse wave for which the duty cycle is 50%. At audio frequencies pulse width modulation produced interesting timbral changes in the sound. One useful sub-audio application would be to control a VCA. The VCA would switch rapidly from zero to full gain. An attenuator on the VCA VC input would be helpful.

Below are the comparator input, reference and output as an example to demonstrate the function:

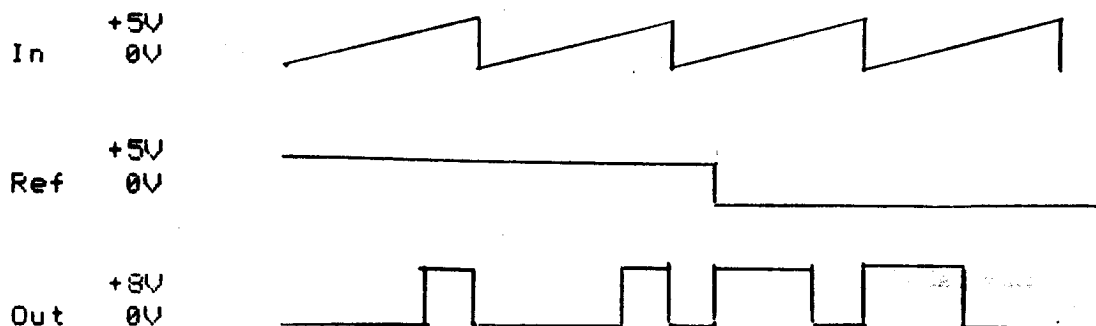

MIXERS

1,2,3 Inputs with associated attenuators
 4 "Wild" inputs
 - + Bias pots for setting output offset voltage
 OUT Main output, non-inverting
 INVERT Main output, inverting

The mixers enable a combination of the outputs of two or more modules, with manual control of the mix. All four inputs are added together. This means that if you put the same signal into two of the inputs turned up full, the output will be twice the input. The Wild input simply has no attenuator. This allows the mixers to be patched together for a six-input mixer. Any signals in the Analog Synthesizer may be mixed, but note that up to $\pm 11V$ may result. The bias pot allows offsetting which is useful when mixing control volages.

VOLTAGE CONTROLLED AMPLIFIERS (DUAL VCA)

VC > Control input for panning and fading
 PAN Bias pot setting initial pan/fade
 1,2 GAIN Bias pots setting individual initial gains
 1,2 IN Respective inputs for VCA 1 and VCA 2
 1+2 IN Input simultaneously to VCA 1 and VCA 2
 1,2 VC Respective gain control inputs for VCA 1 and VCA 2
 1+2 VC Simultaneous gain control input for both VCAs
 1,2 OUT Respective VCA outputs

1+2 Sum of the outputs of both VCAs
 1-2 Sum of VCA 1 output plus the inversion of VCA 2
 output

The VCA provides a means of controlling the gain of a signal by a control voltage. Any signal, including subaudio, may be processed. This module consists of two independent VCAs with provisions for tandem use in various ways.

Each VCA has: 1) an input for the signal to be gain controlled 2) a control input 3) an output. A bias pot sets the initial gain point, then the gain is increased by positive control voltages and decreased by negative control voltages. With the bias pot set for zero gain, a +5V control signal will give unity gain, that is, the output will be identical to the input. Control voltages up to +10V will produce gains of up to two times the input.

Remember that the bias pot adds to the incoming control voltage so that a signal can be doubled by the pot being all the way in combination with a +5V control input. For instance, if a +5V control were used in this case, the output would be varying from zero to two times the input signal amplitude.

The two VCAs are linked in the following ways. First, there is a third control input at the top of the panel for VC panning and fading. This input affects the two VCAs in opposite fashion: as the control voltage increases, VCA 1 gain increases, while VCA 2 gain decreases. As the bias pot is turned clockwise, the same is true. There is also a fourth control input labeled 1+2 VC. This control input affects both VCAs simultaneously in the same fashion as the individual VC inputs. All inputs may be used at the same time on this module.

There is also a 1+2 input which sends the signal to be modified to both VCA inputs. This is used during panning. For fading and voltage controlled mixing there are two mixed outputs of the two VCAs. 1+2 is a normal additive mix, while 1-2 is a different mix. Note that with a signal patched to 1+2 ONN, the 1+2 output may be as high as 4 times gain, while the 1-2 output can never be higher than 2 times gain.

When using this module, first center all three pots. This sets the initial gain of both VCAs to .5. Turning the pan pot will cause one VCA to go to unity gain as the other goes to zero gain. The individual bias pots can be used to balance the overall effect. Leave the pan pot centered for individual use of the VCAs.

For fading, the two signals to be cross-faded are patched into inputs 1 and 2 respectively. The output is taken from 1+2 or 1-2 output. For panning, the input goes to 1+2 IN and the outputs are taken from the respective 1 and 2 outputs.

VOLTAGE CONTROLLED MIXERS (VCM)

HI/LO	Audio/subaudio range selector
GAIN	Attenuator for Main input
Q	Resonance control (also affects gain of Limit input)
VC	Control input with attenuator/inverter for VCO
FREQ	Bias pot setting initial filter cutoff frequency
VC	Control input with attenuator/inverter for VC frequency
LIMIT	Signal input limited by Q setting
MAIN	Main signal input
HP	High pass output
BP	Band pass output
LP	Low pass output

The function of the VCF is to alter the gain of an input signal with respect to that signal's frequency. The filter cutoff frequency is the reference. For the high pass function, input frequencies below the cutoff frequency will be attenuated. The low pass function attenuates frequencies above the cutoff, while the bandpass function attenuates both above and below the cutoff frequency, allowing only frequencies near the cutoff to pass. The Q function determines the sharpness, or closeness to the cutoff frequency, of the attenuating effect.

Since many waveforms contain a complex distribution of different frequencies which determine the timbre or color of a sound, a VCF is often used to modify timbre. Patch a sawtooth wave into the VCF input and manually vary the cutoff frequency. You will notice the common "wah" effect. Listen to each of the outputs and notice the different effects. Notice the action of the Q control. Patch the signal into the Limit input and notice how the signal is attenuated at high Q settings. The purpose of this limiting function is to obtain a more constant output level since the filter "peaks", increases its output amplitude sharply at the cutoff frequency. Higher Q settings produce higher peaks, so the limit function is used to counteract this effect.

Both the cutoff frequency and the Q are voltage controllable, and an attenuator/inverted similar to that on the ramp modules is provided for processing the control voltage coming in.

In LO range, the VCF can be used to modify control voltages. The outputs have a characteristic sinewave pattern, with the BP and LP outputs being 90 degrees out of phase. The BP output leads the LP output by 1/4 cycle. This is different from 1/2 cycle difference produced by a simple inversion. Try patching in a slow ramp and control something with the output.

Finally, the VCF can be made into a VCO by patching the BP output into the Main input. The output will be a sinewave of about $\pm 10V$. The Q and Gain controls must be set fairly high for this to work. Notice that if one of these is decreased slowly, the oscillation dies out gradually, which is sometimes useful.

In this oscillator mode, the HI/LO switch can select audio or subaudio oscillations.

SUGGESTED PATCHES

1. Output of an oscillator to its own VC input. This will yield the concave and convex waveforms diagrammed earlier.
2. Main out of a + ramp to the main input of a - ramp. Using the switch on the + ramp you can initiate a rising ramp (taken from the - ramp main output) that will hold as long as the switch is up and fall when the switch is down. The rise and fall rates can be set individually.
3. Manual gate to the main input of a triangle module. When the switch goes up the main output will rise at the adjustable rate and hold until the switch is turned down, then fall at the same rate it rose (unless you change the rate control in the meantime)
4. Random pulse output to the sample input of the random module. This will yield random levels at the step outputs at random intervals.
5. Pulse output from a - ramp (patched as an oscillator) to the sample input on the random module. This will yield random voltage levels at the step outputs at regular intervals

-- Richard Brewster 1978

-- revised 1984

Jones Oscillators

The Jones Oscillators are multi-purpose plus/minus 5 volt signal generators that can produce sine, square and triangle wave shapes, positive and negative polarities with frequencies ranging from a few minutes per cycle up to several multiples of the horizontal sync rate. This range allows them to be used as sources of control voltages, as audio signals and as horizontally or vertically based shapes which can be graphically combined with video signals. The Jones Sequencer, Colorizer and Keyers are all designed to accept control voltages which can cover the frequency range of these oscillators. In addition, all of the oscillators themselves are voltage controllable and externally syncable.

The signals produced by these oscillators can be used in any of the following ways:

1. As control voltage sources for any of the video signal processors, with the exception of the Paik/Abe Colorizer and the Special Effects Generators.
2. As control voltage sources for any of the above processing modules in the Analog System including the frequency modulation of other oscillators. This allows multi-level controls in the Analog System.
3. As signal sources for any of the processing modules in the Analog System
4. As signal sources to the analog inputs and the digital inputs in the D+7A Box, for interaction with the computer.
5. As audio sources that can be sent directly to an audio amplifier or processed beforehand by modules in the Analog System.
6. As video sources, using one of the two video line inputs, to be routed through the matrix and processed.

Signal Recameters

In any of these applications, four important parameters of the signal need to be considered: frequency, waveshape, gain and bias. Additional considerations are the relative phase of the two signals, and the synchronization of the signal with other control and video events.

Waveshape

The signals' waveshape is the pattern in which its instantaneous voltage changes in respect to time. Three shapes are available, all symmetrical. Each has two separate jacks for outputs of different polarities. Any combination of these six outputs can be used simultaneously.

Frequency

The frequency of the signal is the time it takes to complete one pattern change, or one cycle. The entire range of frequencies available at the outputs is divided up into bandwidths selected by a multi-position rotary switch marked Range. The Frequency knob is used to fine-tune the frequencies within each bandwidth. The frequency of an outgoing signal can be monitored by patching any of the six outputs into one of the multiples located directly below the oscillator bank in the panel. Each multiple has an LED or light which will show both the voltage of the incoming signal, by varying its intensity, and whether it is above or below zero, by indicating red or green. The rate of alternation between green and red indicates the frequency of the signal. Yellow signifies a very high frequency. With the Range switch at a low setting, turning the Frequency knob clockwise yields faster rates. This knob at its right-most position will allow the maximum frequency for the selected Range setting. For the next highest set of frequencies, turn the Range switch one position clockwise and set the Frequency knob to the leftmost position. Then slowly turn it clockwise again.

Gain and Bias

The signals generated at the outputs all have a gain of plus/minus 5 volts and are biased at zero volts. Varying these parameters can happen at a later point in the signal's application.

As Control Voltages

As control voltage sources to video processors, they can be used to change the parameters of the video signals in time automatically, with or without manual interaction.

These parameters can be continuously variable, such as gain, pedestal, clip level, chroma or hue. Or they can possess discrete steps of two, for example key on/off, or more, for example sequencer channels. Continuously variable parameters usually have knobs for manual control and can best utilize triangle and sine waveshapes for voltage control. With a square wave applied to the VC input, the parameter will only alternate between two discrete states within this variable range. These two states will always be equal to one another in duration. Whether or not the transition is continuous or discrete, the total voltage excursion within this variable range is the gain or the control voltage; the center point of this excursion is the bias.

As the signal at the output of the oscillator is at plus/minus 5 volts, the gain is changed by diminishing or attenuating the signal. Some video processors have built-in attenuators for incoming control-voltages. For example, this is true of the four video VCAs and the clip level controls for the Jones Keyers. In most cases however the signal needs to be patched into one of the eight attenuators in the Analog System before going into the VC input of the video processing device.

The bias of a signal is controlled by using the associated knob for that parameter on the processing module itself. Turning this knob clockwise will shift the CV signal's sweep into a higher register within the allowable range of that parameter, while the gain, the size of the sweep itself, is not affected.

Parameters that have only two states are usually controlled manually by switches. In this case the different waveshapes from these oscillators will have the same effect. When the signal rises above zero, one state will occur. When it falls below zero, the other state will occur. Since all of the waveshapes on these oscillators are symmetrical, the two states will be of equal duration.

When using a square wave as a control input for a continuously variable parameter, it is advisable to first patch the squarewave into the jack marked In on one of the Sample and Hold modules and patch vertical drive into the jack marked CK, or Clock. The output of this module when applied to a VC input will allow these discrete transitions to take place during the vertical interval.

There are two outputs for each waveshape. These signals will always be 180 degrees out of phase in relation to each other. One signal will always be high when the other is low. Using these two outputs simultaneously in separate VC inputs is the principle behind alternating two events such as cross-fading or hue modulation.

As Video

Patching one of the outputs of an oscillator into a video line input will convert the plus/minus 5 volt signal into a video signal of .7V with a .3V sync. It is then routed through the matrix. Monitoring the direct output of the video line illustrates the most direct translation of the voltage level of the signal to the gray level of the image. For slow varying control voltages, the entire raster maintains a uniform brightness at any given time, but changes intensity in gradations according to the signal's waveshape. For example, sine waves will yield a continuous gradation between black and white and back again. Square waves will yield either an all black or all white raster of equal durations. Turning up the frequency increases the rate of transition, to the point where flickering occurs. When the frequency exceeds 60 Hz, these transitions between gray levels are no longer perceived as temporal distinctions but as graphic ones. Basically, the time it takes the signal to complete one cycle, from high voltage to low and back to high, is shorter than the time it takes the video scanning process to display one field on the raster. Within a single field of video, the first few horizontal lines at the top of the raster are black, then successive lines become brighter, until they reach a maximum brightness. The next lines become darker again. The gray levels on the raster are the same from left to right across each horizontal line but change intensity

from top to bottom or along the vertical axis. The illusion created is horizontally-oriented bars.

Sync Inputs

The bars appear to roll because the signal is not at the same point in a cycle for the start of every video field. Patching vertical drive into the Sync Input of the oscillator will cause the beginning of each cycle to be in step with each vertical interval. This will appear as locked bars on the raster. Either sync input can be used. The two jacks are bridged for syncing several oscillators together. Increasing the frequency increases the number of bars, or the number of times the field is divided vertically. This also decreases the number of raster lines used to display each cycle of the signal.

The next threshold frequency to consider is the point at which the number of scan lines is too small to resolve a cycle of a full transition between white and black and back. When the frequency of the signal approaches 15,750 Hz, or the number of fields per second multiplied by the number of lines per field, the changes in intensity are occurring as fast as the scanning process can display each horizontal line on the raster. Therefore changes in gray levels take place at points along each line. In order to have the signal be at the same point in a cycle at the start of each scan line, horizontal drive must be applied to the sync input of the oscillator, instead of vertical drive. Now the brightness of the raster is equal for any given point along the vertical axis or from top to bottom, but the raster changes intensity from left to right. This yields vertically oriented bars.

Combining Oscillators

When used in this way, two or more oscillators combined will result in complex shapes. Usually one oscillator, synced to vertical drive, is producing a signal between 60 Hz and 15KHz. Another oscillator, synced to horizontal drive, has a signal above the line rate. Using two square waves at the outputs will produce box-like shapes or ones which divide the raster at right angles. Combining the two oscillators can be done one of two ways. Their outputs can be patched into two separate video lines and routed at the matrix through video processors such as the video mixers, the SEGs in fade/mix modes or the Paik/Abe Colorizer. Or they can be combined directly within the Analog System using the three-input mixers or the dual VCA. From there, the combined signal can either go into a single video line converter to be processed or directly into the control voltage input of certain video processing devices. The Jones Colorizer, Sequencer and Keyers were all designed to accept control voltages which cover the full frequency range of these oscillators. Other devices, the Four Channel Squencer, the two control voltage keyers and the four video VCAs will respond to control voltages that are up to several multiples of the field rate.

Voltage Control of Oscillators

Finally, these oscillators are voltage controllable, by patching signals, including ones generated by other oscillators, into the VC input jack and adjusting the attenuator pot. The pot turned to the right-most position allows the maximum sweep to occur. The incoming control voltage will only modulate the frequency within the bandwidth designated by the Range Select switch. When using an oscillator for slow-varying control voltage, this VC input allows for a second level of control, which alters the rate at which the first signal changes. When used as a video source or a control voltage less than 60 Hz, this will change the number of divisions of the raster along either the horizontal or vertical axis. When used to generate audio signals, this will modulate the pitch of the signal. The frequency range for audio signals should be between 15 Hz and 18 KHz.

Voltage Control of Oscillators

Finally, these oscillators are voltage controlled, by patching signals, including ones generated by other oscillators, into the VC input jack and adjusting the attenuator pot. The pot