

Ref 457 for JL
RS 11/20/74

RE

VIDEO

SYNTHESIZER

SYSTEMS

Models RE4-A and RE4-B

RUTT ELECTROPHYSICS CORP.

21-29 West 4th Street, New York, N.Y. 10012 (212) 982-8300

CONTENTS

<u>Page</u>		<u>Page</u>	
1 -	SYSTEM FLOW	12-	<u>WAVEFORM GENERATOR</u>
2 -	HOW THE SYNTHESIZER WORKS		FREQUENCY KNOB
3 -	SETTING UP		FREQUENCY SELECT SWITCH
4 -	STARTING UP - <u>DISPLAY CONTROL UNIT</u>		VERTICAL Frequencies
5 -	BIAS CONTROLS		HORIZONTAL Frequencies
	HEIGHT	13-	SYNC SELECT KNOB
	WIDTH		AM KNOB
6 -	DEPTH		AM BIAS
	INTENSITY		AM LEVEL
	HORIZONTAL	14-	AM VARIABLE
7 -	HORIZONTAL CENTER		LED
	VERTICAL		
	VERTICAL CENTER	14-	FM LEVEL
8 -	LEVEL CONTROLS		FM INPUT
	RAMP GENERATOR		FM with RAMP GENERATOR
9 -	RAMP (continued)	15-	DUTY CYCLE
10-	DUAL TRACE		W.G. OUTPUTS
11-	ROTATION	16-	<u>AUDIO INTERFACE</u>
		17-	<u>SUMMING AMPLIFIER</u>
		18-	<u>DIODE MODULE</u>
		19-	" "

SYSTEM INFORMATION FLOW

- (A) VIDEO INPUTS may be from a TV camera, video tape playback, video character generator or key outlining shapes from a special effects generator.
- (B) THE SYNTHESIZER: Display Control Unit, Module Rack and Display (RE4-A scans 525-line or other prevailing standard; RE4-B scans 945-lines as well as standard scan rate.)
- (C) RESCAN CAMERA reconverts video information back into scanning deflection pattern which is compatible with the standards of a recorder and other equipment.
- (D) COLORIZER - a separate unit or part of the switcher or effects generator - inserts color into the synthesizer's monochrome images.

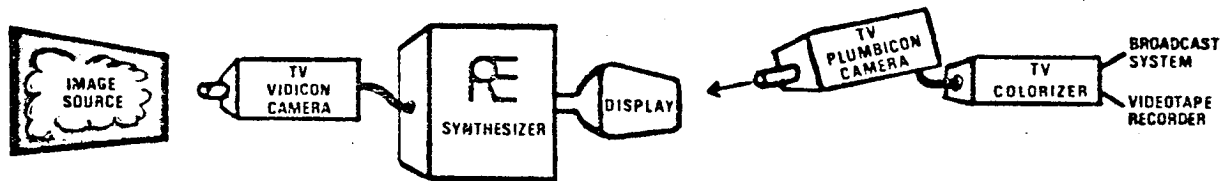

VIDEO INPUT

SYNTHESIZER
& DISPLAY

RESCAN
CAMERA

COLORIZER

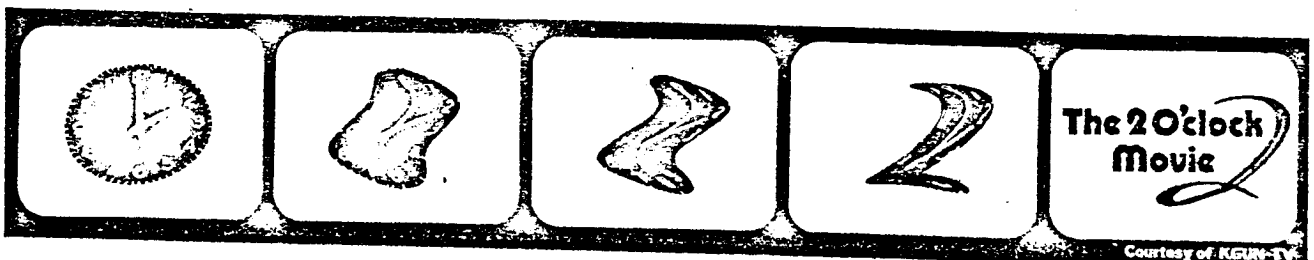

Courtesy of KGM-TV

How the Synthesizer Works

The synthesizer may be thought of as a super-sophisticated TV set. It accepts video signals from any standard TV camera, recorder, special effects or character generator. (Fig.2A)

Ordinary sets have rear-access controls to squeeze and stretch their picture. This is done by shortening or lengthening the horizontal scan lines of the raster and by moving those lines closer together or farther apart than normal. However, the synthesizer manipulates the raster, and the images it displays, in many more ways.

To do this, the raster-forming commands of the synthesizer go far beyond the parameters of standard recording and broadcast equipment. To bridge this gap, the synthesizer displays its image transformations on its own high resolution CRT. These real images are then rephotographed (rescanned) by a standard TV camera. This passes along to the rest of the system these images within a standard raster-scanning format. (Fig.2C)

The synthesizer processes video signals in monochrome. After being rescanned, however, these images may be colored in the colorizing circuits of a switcher, special effects generator or in a separate multi-level colorizing unit. (Fig.2D)

Visual Input Materials

High contrast white-on-black titles, line drawings, diagrams and background patterns lend themselves to decorative and functional transformations. Directly as white images, or after being colorized, they may be superimposed by keying over other color or monochrome scenes and backgrounds.

Shades of black, greys and white may also be used in original artwork. If well-defined in the original, each of these shades will be well differentiated on the synthesizer's CRT screen. After rescanning, they will provide differences in brightness levels to which can be assigned different colors in a multi-level colorizer (also called a quantizer). (Fig.2D)

Still or moving continuous tone pictures will also be well-reproduced by the synthesizer in monochrome. While these images may also be colorized, they will not end up as "natural" color pictures. The action of the colorizer will enable you to obtain unusual solarized or posterized color effects in their rendition.

Synthesizer Zen (You Become the Feedback Circuit)

Most variable control knobs on the synthesizer have no reference scales on the panel. Instructions for operating them are given here in approximate numbers of turns. Experience shows, however, that with your hands on the controls and your eyes on the image as it changes on a monitor screen, you become a part of the system, acting as the controller in a feedback loop (the same way you drive your car). Happy driving!

SETTING UP

After unpacking the synthesizer, check the parts received with the PARTS LIST to the right, and you are ready to assemble the synthesizer.

- | PACKING LIST | |
|-------------------------|--------------------------|
| 1. DCU | 7. - SUMMING AMPLIFIER |
| 2. DISPLAY UNIT | 8. - DIODE MODULE |
| 3. MODULE RACK | 9. - AUDIO INTERFACE |
| 4. - WAVEFORM GENERATOR | 10. Display to DCU Cable |
| 5. - WAVEFORM GENERATOR | 11. DCU to Module Cable |
| 6. - RAMP GENERATOR | 12. AC Cord |
| | 13. Patch Cords |

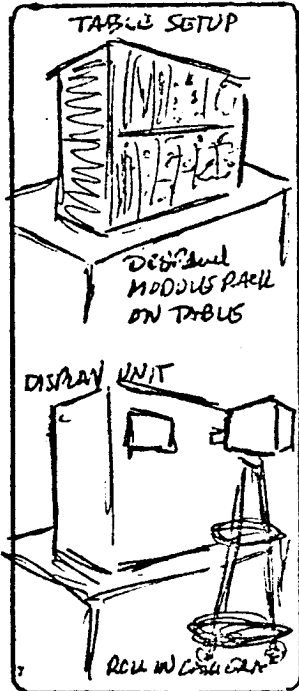

1. DISPLAY CONTROL (DCU) & MODULE RACK

The DCU and Module Rack may be rack mounted...or stacked on a table. Mount the DCU above the Module Rack. Thus, patch cords from jacks along the bottom of the DCU front panel will hang out of the way of its controls.

2. DISPLAY UNIT

If the Display Unit is rack mounted its screen faces downward for rescanning by a permanent camera on a rack beneath. Otherwise the Display may be set on a table with its screen on a vertical plane. This permits studio or other cameras to be rolled up to face the Display screen.

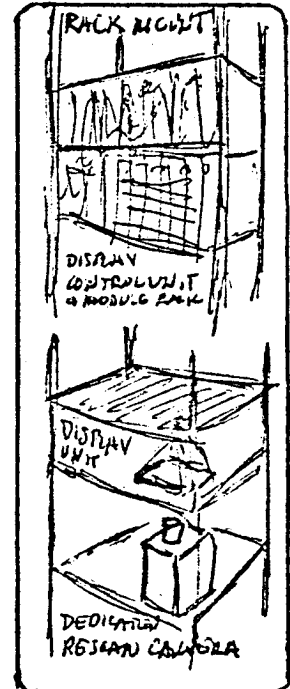

3. CABLES

Connect the long, thick cable to the back of the DCU marked "to Display", and the other end to the Display marked "to DCU". Connect the small cable to DCU back marked "to Modules" and the other end to the connector marked "Modules".

4. FEED VIDEO TO DISPLAY

The synthesizer accepts composite video and has a gen lock to facilitate this. Connect your video source with a BNC connector to the Display at "Video In", which has built-in 75-ohm termination.

GRAPHICS CAMERA Use a black-and-white vidicon camera of a quality consistent with your system. A white clipper or a keyer will increase image contrast.

For the RE4-B Model use a 945-line monochrome graphics camera.

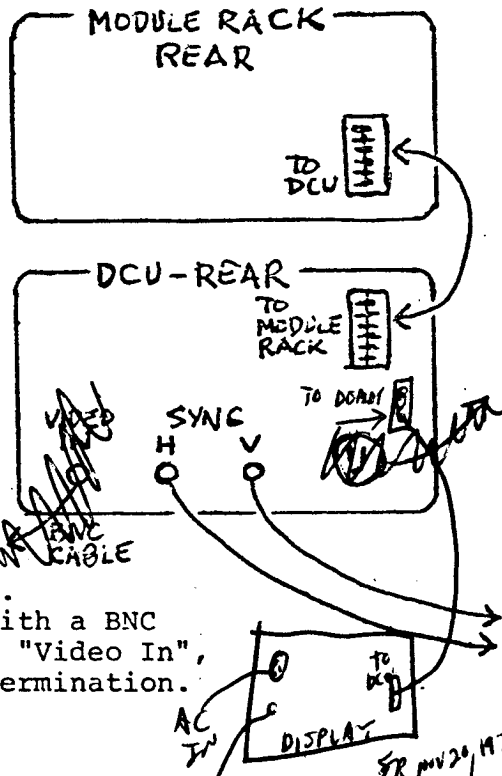

(3-continued)

The second "Modules" connection is for added accessory modules (see APPENDIX).

Connect AC cord from Display to available 115 volt power outlet.

6. VIDEO SYNC OUT

H and V Sync Out jacks on the Display lock outside sources like rescan camera to the synthesizer gen lock.

RESCAN CAMERA Use a monochrome camera with a plumbicon tube. This avoids image lag inherent to vidicons. You may use a vidicon, however, in such less exacting applications as for "video art" effects.

STARTING UP: The Display Control Unit (DCU)

Here is a standard set of startup procedures for the DCU. It is important to follow this for correct interpretation of subsequent instructions. It is also vital that the INTENSITY and BLACK LEVEL controls be kept in proper adjustment to avoid burning the tube's phosphor. Be constantly aware of the brightness and size of your image. If an image of normal size and brightness is reduced to a small dot, without lowering its intensity, its concentrated energy will burn the tube instantly. (*)

1. The BLACK LEVEL switch should be in the UP position, and its slider pot in the DOWN position. The other switch position, PREVIEW, allows you to see the entire raster to be able to determine how you are reshaping it...without disturbing the intensity settings.
 2. The DUAL TRACE switch should be on POSITION, with its slider pot in the DOWN position. (Only the "1" BIAS and LEVEL controls will be operative with the Dual Trace slider all the way down.)
 3. Keep the ROTATION 0/90° switch in the OFF position. Only later might you need to switch this ON. Thereby you will upend an image on its side, when so required by its composition, for horizontal division by the DUAL TRACE feature.
 4. Check that the H and V SYNC switches are both set on INTERNAL. This will keep your Modules and Display in sync.
 5. All BIAS knobs for HEIGHT, WIDTH and DEPTH should be turned clockwise all the way.
 6. All BIAS knobs for INTENSITY, HORIZONTAL, H. CENTER, VERTICAL and V. CENTER should be turned clockwise all the way and then reversed five turns to the left.
 7. All LEVEL knobs should be turned counterclockwise all the way.
- (*) Synthesizers factory-equipped with the AUTOMATIC INTENSITY COMPENSATION accessory will avoid the possibility of burns.

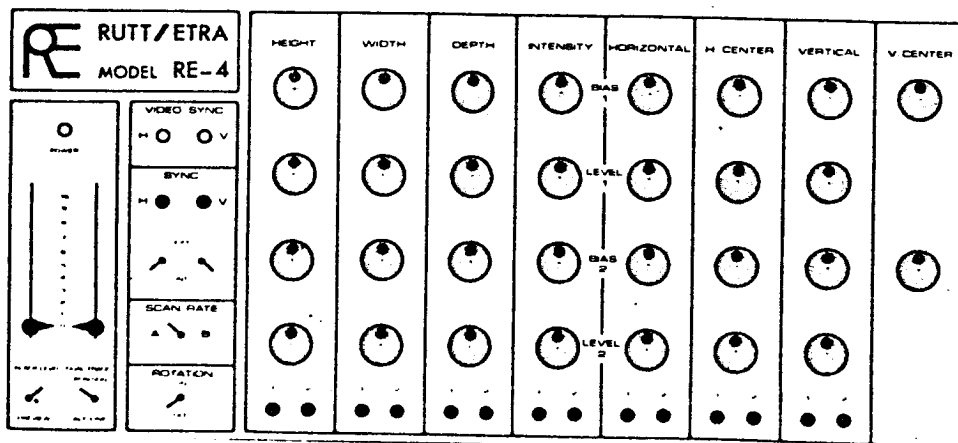

BIAS CONTROLS

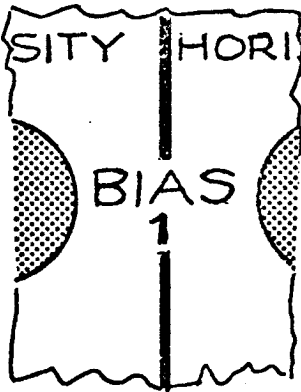

The BIAS CONTROLS output voltages to change the shape and position of the synthesizer's display raster and image. Each of the eight different Bias controls (for HEIGHT, WIDTH...etc.) is capable of ten turns. As you will see in the following diagrams, all but two of these controls, turned left-to-right, output from -10V through 0 to +10V. DEPTH and INTENSITY do not generate negative voltages as do the other BIAS controls. Turning from left-to-right, DEPTH and INTENSITY output 0 to +10V in ten turns.

For the moment we shall use only those BIAS controls on the tier marked "1". They affect the whole raster as a single entity when the DUAL-TRACE slider pot is down. (Later we shall use the "2" tier of controls when we come to discuss DUAL-TRACE functions.)

The HEIGHT Bias outputs a voltage which varies the amplitude of the vertical sweep. This is similar in function to the height control on a standard receiver.

The Bias control, according to set-up procedures, should be a full clockwise position. This outputs maximum positive voltage, creating the maximum height of the image. Now turn the knob counterclockwise. Watch the image decrease in height until it becomes a horizontal line, which is 0 volts. Continue to turn the knob counterclockwise. The image will begin to increase in height again, but as an inverted image. The inversion is caused by the negative voltage. At full counterclockwise position, the image should be maximum size and inverted.

....Return to the beginning position....

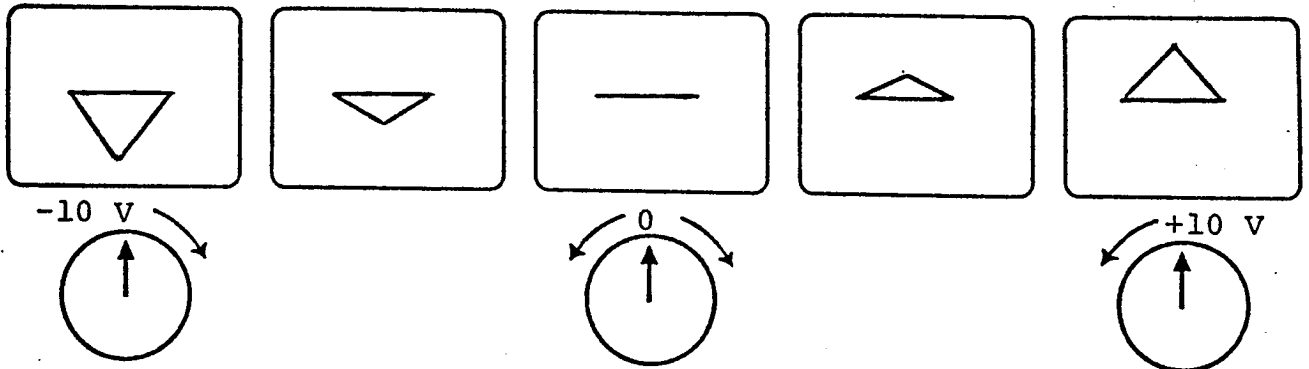

The WIDTH Bias outputs a voltage which varies the amplitude of the horizontal sweep. This causes the image to increase in width with a positive voltage, but in an inverted position with a negative voltage. Explore this by turning the Width Bias counterclockwise. At five turns the image should become a vertical line signifying 0 volts. Continuing on, the image will expand again, this time in an inverted position, until it reaches maximum negative voltage at the full counterclockwise position.

...Return to the beginning position....

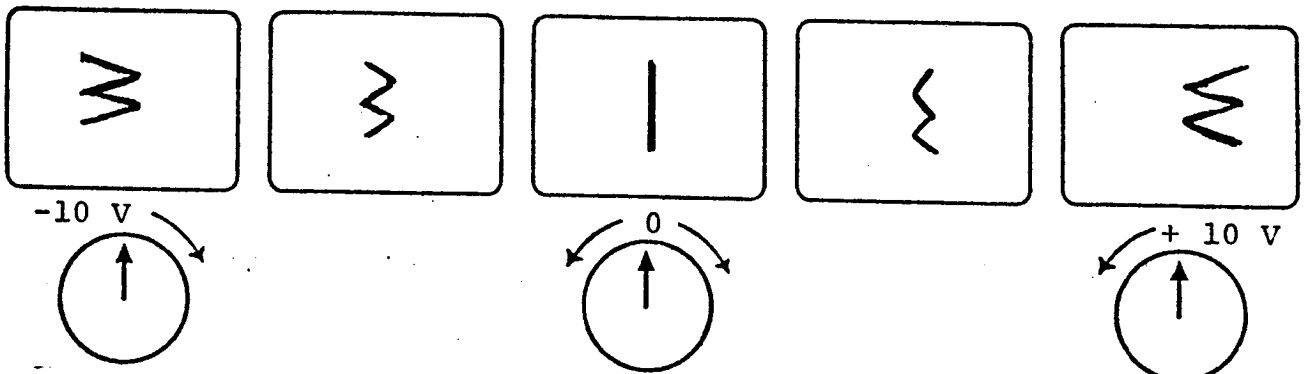

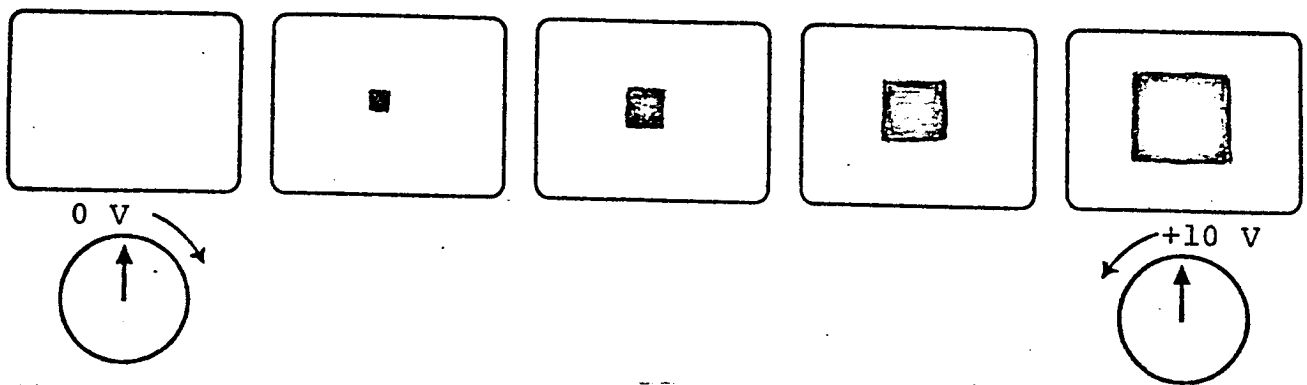

DEPTH varies the height and width of an image simultaneously, causing the image to appear to advance or recede. This Bias control differs from Height and Width in that it does not put out a negative voltage. Thus the full counterclockwise position yields 0 volts, reducing the image to a small dot. Since its brightness is all concentrated in this small area, the dot is extremely bright and can easily burn the tube phosphor.

An INTENSITY control is provided to avoid overbrightness. It is located alongside Depth, and the two should always be used together. Examine Depth by turning the Bias knob counterclockwise. As the size reduces and becomes brighter, turn the Intensity knob counterclockwise also. By doing this the dot should totally disappear before it reaches 0 volts, the full counterclockwise position. (Depth/Intensity variations can be linked automatically during animation when used in conjunction with the Ramp Generator.)

....Return to the beginning positions for Depth and Intensity....

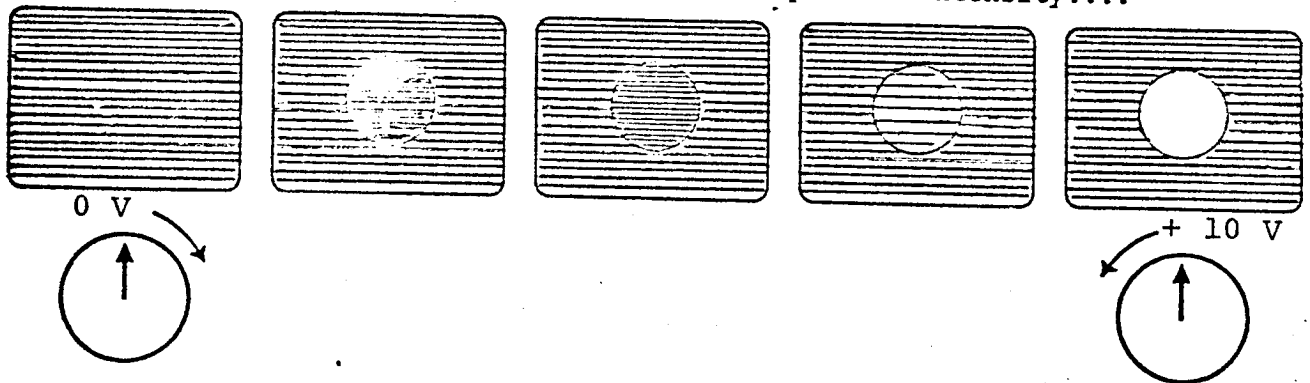

The HORIZONTAL Bias moves the display raster as a whole within and off the screen. Positive voltage - the knob moved from the center in a clockwise direction - shifts the raster to the right. Negative voltage - the knob to the left of center in a counterclockwise direction - moves the raster to the left. Experiment by rolling the raster off the screen to the right (clockwise knob rotation) and then to the left off the screen (counterclockwise knob rotation).

....Return to beginning position....

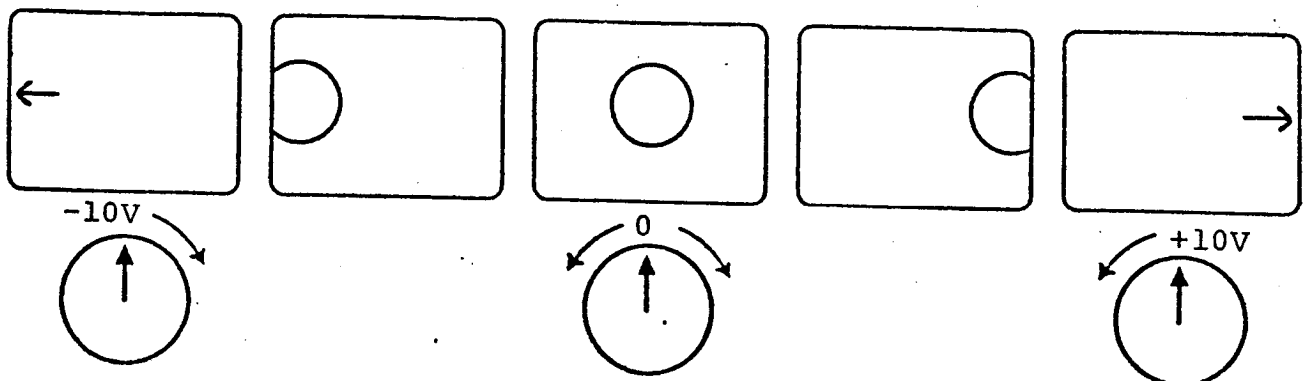

HORIZONTAL CENTER differs from Horizontal in the following respect. Horizontal moves the whole display raster and the image thereon. HORIZONTAL CENTER moves the incoming image through the raster...without disturbing the raster's shape. Therefore it is possible, first, to reshape the display raster into, say, a form resembling the corner and two visible sides of a theatre marquee, including realistic perspective foreshortening. Then, with Horizontal Center, you can roll the image through this specially-shaped raster. As the image slides across the screen it conforms to the changes in shape at each point of the raster through which it is moving.

You can experiment with this simply by raising the Black Level slider pot until the display raster itself becomes visible. Then, however you modify the raster shape with DCU controls, you will see that Horizontal Center moves the image through, and in conformity with the shape of, the raster, without disturbing the raster's modified shape.

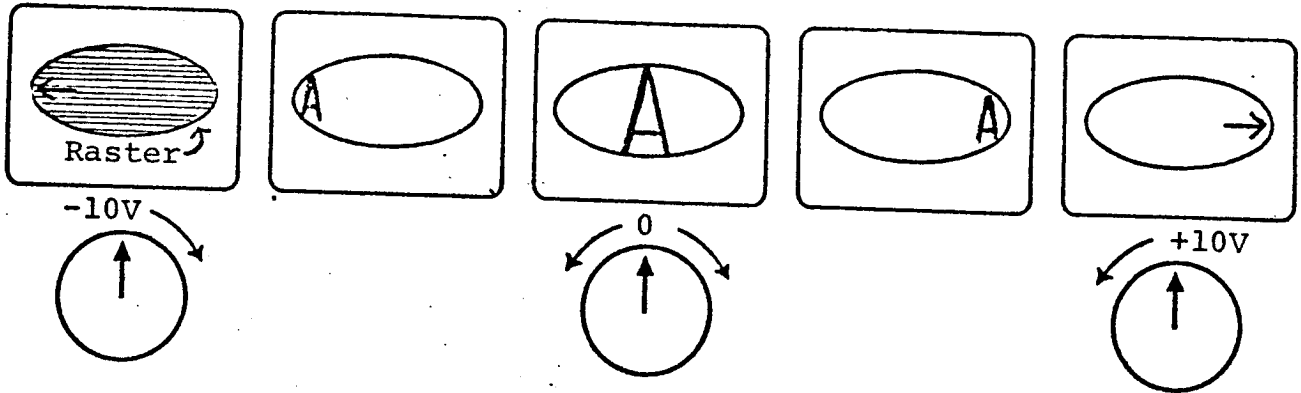

VERTICAL Bias pans the raster up and down. From the center position (five turns in from its extremes) turn the knob clockwise. The image rises up and off the top of the screen. Turn the knob counterclockwise. The image will sink down and eventually disappear off the bottom of the screen.

....Return to beginning position....

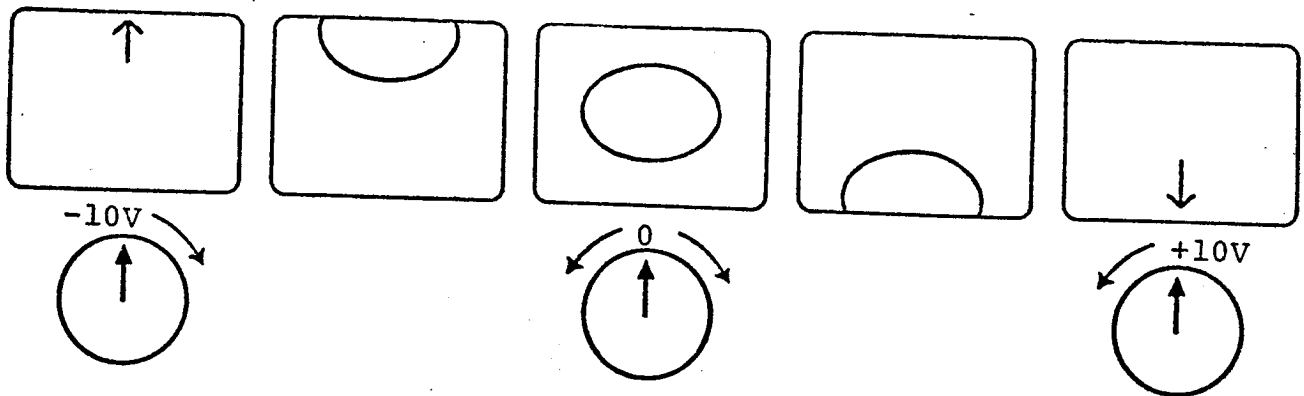

VERTICAL CENTER is not the alternative to Horizontal Center. It raises and lowers the axis around which an image appears to rotate when the Height control is moved back and forth. In other words, Vertical Center adjusts, up and down, the Height control's 0 voltage point (the horizontal axis around which it rotates an image).

Vertical Center is particularly helpful in establishing a common horizontal axis of rotation for two images when each is being manipulated independently through Dual-Trace division of the incoming video raster.

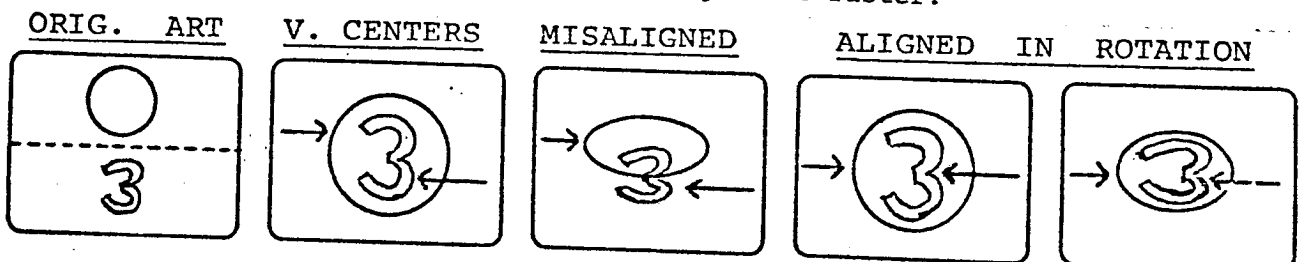

LEVEL CONTROLS

The LEVEL controls (on the 2nd and 4th tiers of the DCU panel) do not generate voltages as do the BIAS controls above them. Level controls act as potentiometers, allowing more or less voltage from outside sources to pass to the deflection circuits.

Here's a diagram showing the differing roles played by the LEVEL and BIAS controls in altering the DISPLAY deflection circuits:

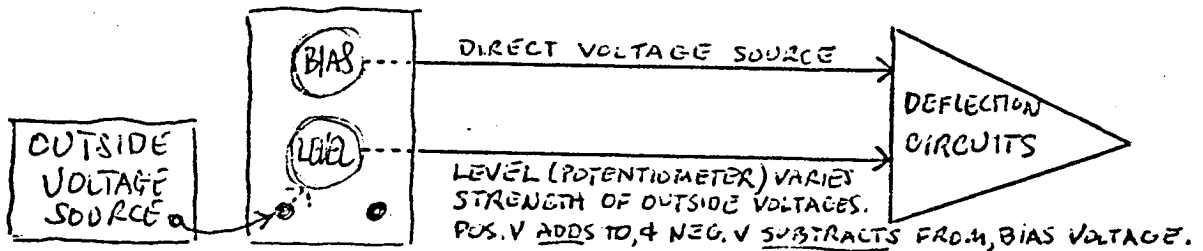

The outside voltage sources (above) include the Ramp Generator, Waveform Generator, Summing Amplifier, Audio Interface and voltages passed through the Diode Module. Let's examine the RAMP GENERATOR first:

RAMP GENERATOR

The RAMP GENERATOR provides a one-way linear change of voltage, changing at a constant rate determined by the TIME control setting. From 0-to-10V it operates as an UP ramp; from 10V-to-0 as a DOWN ramp. Choice in the use of either of the two OUTPUT JACKS (+ & -) at the bottom determines whether the voltage from the Ramp will be positive or negative.

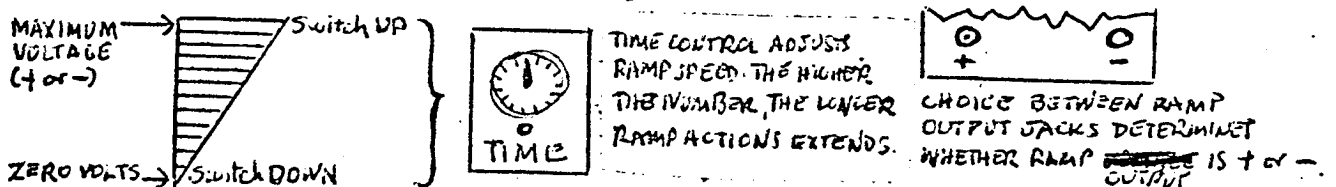

ANIMATION with the RAMP GENERATOR - is a three-step process:

- (1) With the RAMP GEN. disconnected - or its switch set at DOWN, if already patched to the DCU - adjust one state of the image with voltages from the (DCU) BIAS controls.

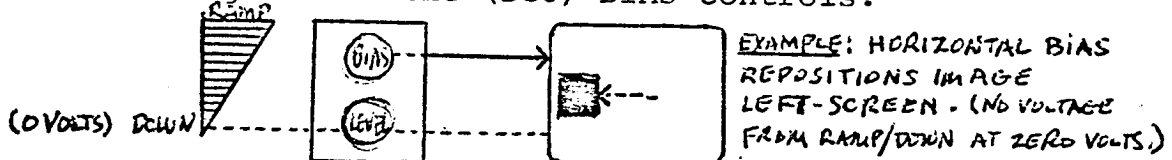

- (2) Switch RAMP to UP (maximum voltage). With RAMP patched into appropriate DCU inputs, adjust its voltage with LEVEL potentiometers in order to change image to its second state. The Ramp voltage is thus added to the BIAS voltage (if Ramp output used is positive) - or subtracted (if Ramp voltage is negative).

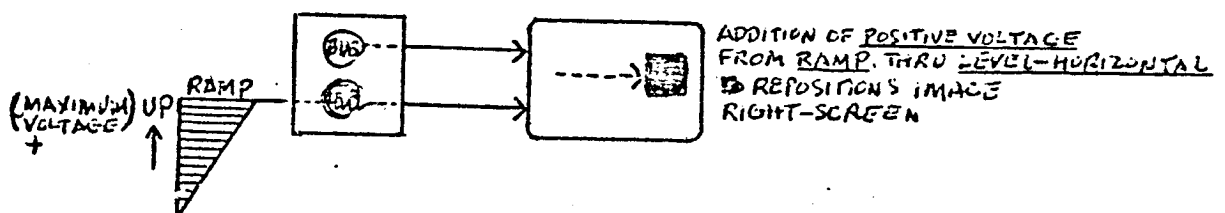

- (3) When you change Ramp switch to DOWN again, the Ramp travels from maximum voltage down to zero voltage (at speed set by TIME control). As Ramp voltage descends, its influence on the image, previously established by adjustment of the LEVEL controls, diminishes to zero. The image responds by changing from its state determined by the combined BIAS & LEVEL controls, to the state initially determined only by BIAS voltages.

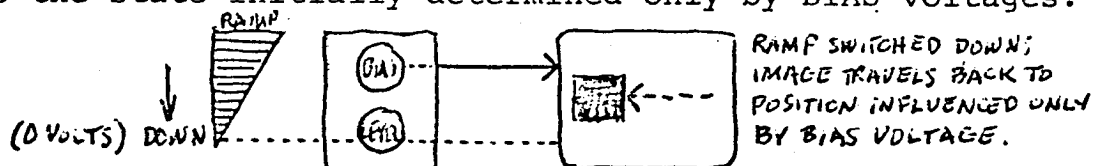

And, of course, if you switch Ramp again to UP (maximum voltage):



Now...just to make sure you've "got it", practice the following:

1. Be sure switch at left is on RUN. Later, during image animation, you may for any reason stop the ramp action instantly by shifting this switch to HOLD. Switch it back to RUN when you continue.
2. With the Ramp disconnected (or with switch set to DOWN) adjust the (DCU) BIAS controls. (Later you may have various MODULE controls patched into the DCU controls, too.) Continue adjustments until the image is at one extreme of your sequence.
3. Now shift the Ramp to UP. Use LEVEL controls (to which the Ramp has been patched) to adjust the image to its other terminal point in your animation sequence.
4. With this setup activate the animation sequence by switching from UP-to-DOWN or from DOWN-to-UP. NOTE: While building a sequence, you need not wait for the ramp action to consume its full travel time (set by the TIME control). Simply press the SET button and the image will jump forward to its termination.

You can create a second and differently transformed sequence with the same image. But if it is to be edited without a jump, as a smooth continuation from your first sequence, use only the UP-to-DOWN Ramp action to animate your first animation. This terminates the Ramp at zero voltage (DOWN). You can repatch and readjust your LEVEL settings (with Ramp UP) without disturbing the image control of your Ramp DOWN/BIAS settings. Now, record the new DOWN-to-UP Ramp action, and the two sequences will edit together without an image jump!

You cannot, however, go on to a third connecting sequence in the reverse Ramp direction. Reason: you would have to alter your BIAS settings. This would alter the effect of the LEVEL adjustments, which merely add (if Ramp is +) or subtract (if Ramp output is -) relative to the basic BIAS voltage (see diagram, top of preceding page).

Later we'll discuss the DIODE MODULE. With it you can, during the progress of a Ramp action, predetermine a point where different preset controls will "cut in" to alter the ongoing mode of animation.

DUAL TRACE

The DUAL TRACE feature controls switching of different parts of the video raster between DCU Controls Group "1" (upper two tiers) and Controls Group "2" (lower two tiers).

With the switch on POSITION: Adjustment up-or-down of the slider pot will determine at which horizontal line the dividing point will be. The image in the area above this line is manipulated by Controls Group "1". Group "2" manipulate the image in the area below this line. These manipulations are simultaneous but independent, even to the extent of overlapping independent images on the DISPLAY.

With switch on ALTERNATE LINE: Each successive horizontal of the incoming video is switched alternately between Controls Group 1 and 2. In this mode the slider pot is inoperative. The image is thus duplicated, for control independently by the two sets of DCU controls.

The two alternate line images will, of course, be defined by half the original number of horizontal scan lines. This will not be apparent in gross images. With the 945-line scan capability of the RE4-B Model, resolution loss in even fine detail will go unnoticed.

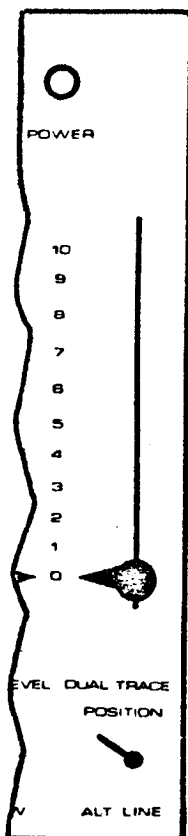

Switch on POSITION

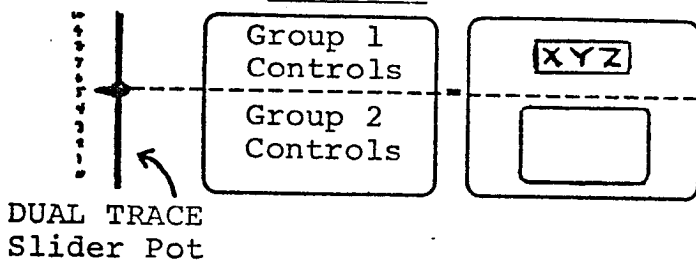

Switch on ALT. LINE

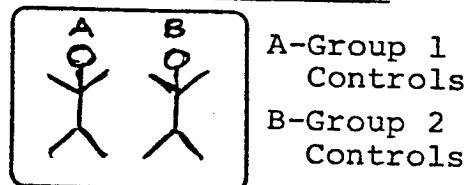

DUPLICATED IMAGE

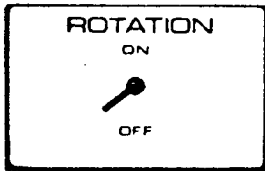

When ROTATION is switched ON, it rotates the incoming video 90°. This permits images, which would be better processed that way, to be displayed with their horizontal axis in a vertical plane.

There are two fairly commonplace situations where this twisting of the incoming video image proves to be advantageous:

1. In connection with the DUAL TRACE Feature - When two images are to be separated by Dual Trace division, for independent manipulation in DCU Controls Groups 1 and 2, they must be composed in the camera one above the other. They may then be divided at any horizontal line by adjustment of the Dual Trace slider pot.

But if these images are predominantly vertical in their composition, their images will be quite small in the camera frame when stacked one above the other. They will thus be defined by a relatively small number of horizontal lines, and their resolution will suffer. By preparing their artwork, so that these images are composed in a predominantly horizontal composition, they can be much larger in the frame, with better resolution. Turning ROTATION ON, will upend these higher resolution images. They may then be divided at the appropriate horizontal line with the DUAL TRACE slider pot...and you can proceed to manipulate them as you desire, using DCU Controls Groups 1 and 2.

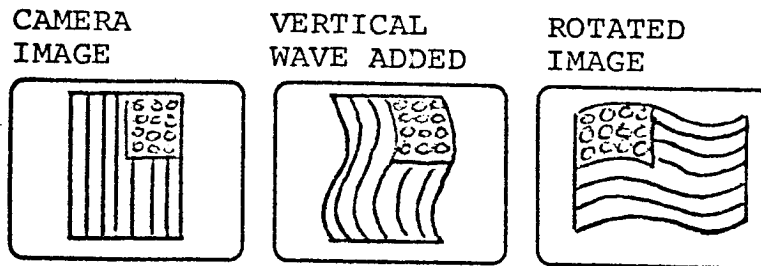

2. Displaying VERTICAL WAVEFORMS on a HORIZONTAL PLANE - You want to use the shaping or animating characteristics of a vertical waveform on an image...but to have those characteristics displayed on a horizontal plane. The answer is to compose the image in the camera on its side (see diagram). Then, when you apply the vertical waveform to this image...with the image rotated 90° on the Display by having the ROTATION switch ON...the vertical waves will affect the now properly oriented image as though they were horizontal waves.

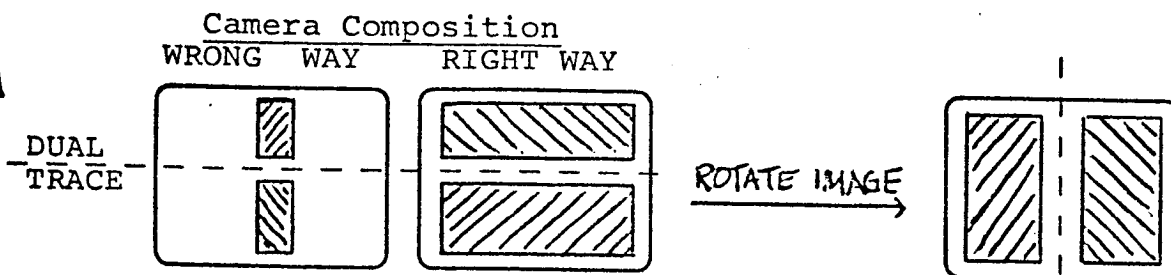

WAVEFORM GENERATOR (Lets call it the WG)

Earlier we saw that the Ramp Generator, when combined with DCU functions, animates images by providing a linear change of voltage moving in one direction from 0-to-Maximum or from Maximum-to-0 voltage.

The WAVEFORM GENERATOR, however, produces voltages which rise and fall continuously, ranging from -10V through 0 to +10V. Expressed visually, these voltages fluctuate in three basic waveforms:

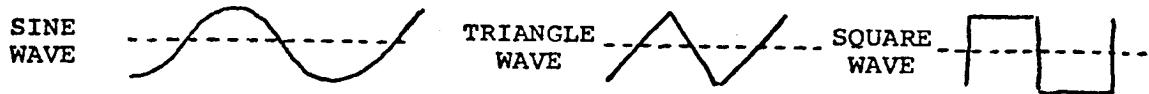

These waveforms are changed in seemingly endless ways by the various WG controls as well as by combination with the second WG or other Modules.

Here are four basic ways waveforms, in concert with DCU control circuits, may alter images:

- A. By imparting a fixed shape to a static image.
- B. By causing a waveshape to run through the image (e.g. waving flag) without altering image location.
- C. By moving an image in space (with or without changing its shape).
- D. By first reshaping the raster, and then, using HORIZONTAL CENTER, by moving the image through the raster, causing the image to change its shape as it conforms to the changing raster shape at each point in its travel.

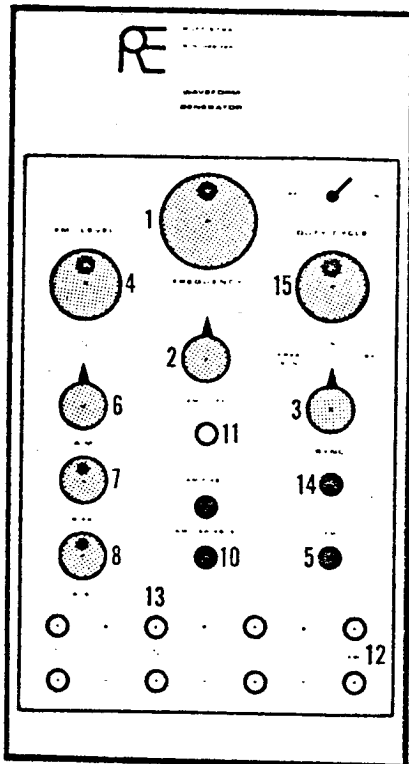

WAVEFORM GENERATOR CONTROLS

FREQUENCY Knob (1) Acts as a fine-tuning control traveling through a range of frequencies selected by the Frequency Selection Switch.

FREQUENCY Selection Switch (2) Switches between a choice of three frequency ranges: L, V and H.

The LOW frequencies, when combined with DCU functions, create continuously repeating movements similar to those produced in only one direction by the Ramp Generator.

The waveform travels at a slow enough rate to carry the image back and forth from side-to-side (patched to HORIZONTAL) or up-and-down (patched to VERTICAL). The three different wave shapes impart different qualities of motion:

SINE (smooth); TRIANGLE (sharp); SQUARE (stacatto).

VERTICAL frequencies range through oscillations matching the rate of the vertical sweep (60 cps) and multiples thereof.

These frequencies enable a whole waveform cycle to appear within a single frame of video. Thus, when the frequency is exactly 60 cps, the image will be reshaped with one static wave curve. At 120 cps two curves will appear in the image shape...and so on through multiples of 60 cps. When frequencies in this range are out of phase with the vertical scan rate or its multiples, the waveform will run through the image without changing its location on the screen.

HORIZONTAL frequencies oscillate in the range of 15,750 cps and above. When these frequencies are in phase with the horizontal scan rate or its multiples the image is reshaped with complex curves.

SYNC Selection Knob (3) Wave frequencies can be switched to run freely, or they can be locked into sync with raster scan rates (vertical or horizontal depending upon which the Frequency Selection Knob selects).

FREE RUN allows out-of-phase wave forms to run freely through the image.

INT - (Internal Sync) locks the wave form into a static position. It triggers each cycle of the wave to start at the same time as each vertical field or horizontal line of the raster is generated. This shapes images without altering their location. Movement of images, in this case, would be created by waveforms output through the AM control.

EXT - (Exterior Sync) triggers waveforms to start at the pulse from a second WG as the latter starts its vertical or horizontal scan. Such external equipment should be fed into the WG at the SYNC Input (14).

AM Knob (6) This controls the amplitude of any given wave frequency. It can be set to feed out a sine, triangle or square wave form through the (+) or (-) AM OUTPUTS (12). In effect, it increases or diminishes the magnitude of image shaping or movement, at any given frequency. This is similar to the function of a volume control on a sound amplifier.

AM, used in conjunction with the Ramp Generator, automates a one-way change of waveform influence. This is useful for fading in or out the static or dynamic waveform effect upon an image. To accomplish this, AM has its own AM BIAS (7) and AM LEVEL (8) controls for use in connection with the UP/DOWN positions of the Ramp switch.

Patch the Ramp into the AM VARIABLE Input (10). Start with the Ramp switch DOWN (and the other switch on RUN). Adjust the Frequency controls (2 & 1) and then establish the amplitude of the waveform with AM BIAS (7).

Now, with the Ramp switch UP, adjust the AM LEVEL (8). If, for instance, the AM BIAS setting is at zero volts, the amplitude of the wave set by AM LEVEL will fade out when you switch the Ramp back to DOWN. If you switch the Ramp back to UP, the waveform's influence will fade in.

In any case, the Light Emitting Diode (11) will light up to let you know when the AM voltage is at zero volts.

Here's a diagram of four possible adjustments of the RAMP and your AM BIAS and LEVEL controls...to fade out or fade in waveform influence on your image:

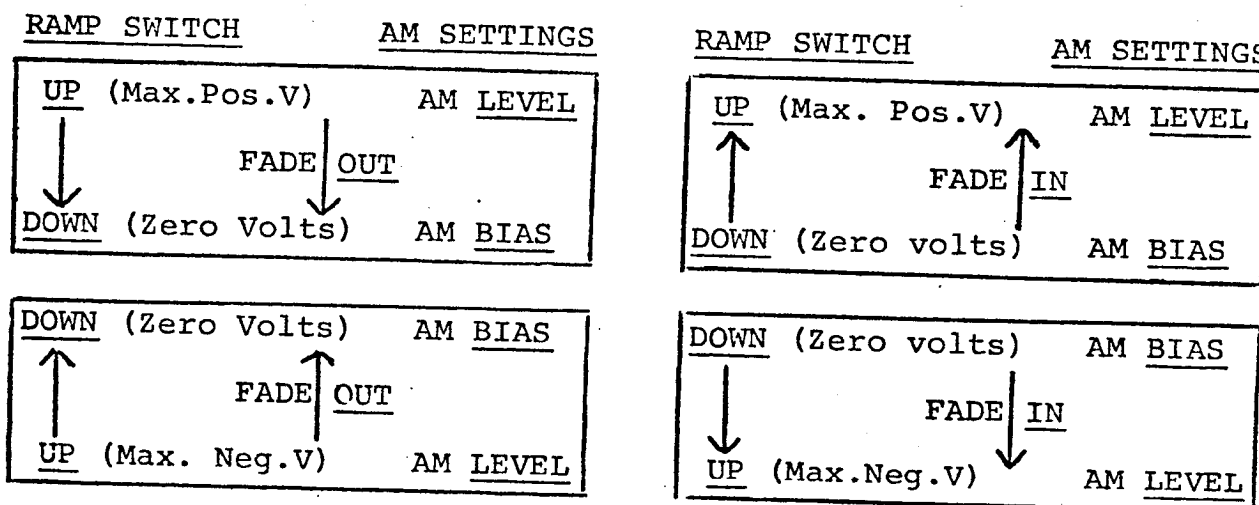

NOTE: Always adjust your AM BIAS setting first, with the RAMP switch DOWN.

FM LEVEL (4) This control (a potentiometer) passes more or less of the voltage from an external source to change the frequency of a waveform.

Using FM LEVEL with the Ramp Generator

First, establish a waveform frequency with the Frequency Select Switch (2), fine-tuning it with the Frequency Knob (1). This creates one state of the image.

Then, to create another image state, patch the Ramp Generator voltage output to the FM INPUT (5). Switch the Ramp Generator to UP. Modify this voltage, now, using the FM LEVEL potentiometer, thereby changing the wave frequency to alter the image.

Now, when you turn the Ramp Switch DOWN, the image will undergo a gradual transition back to the state set first with the Frequency controls (4 & 5).

DUTY CYCLE (15) This control, ranging from -10V through 0 to +10V changes the percentage of the positive (upward) slope in relation to the negative (downward) slope of a waveform.

SINE WAVE

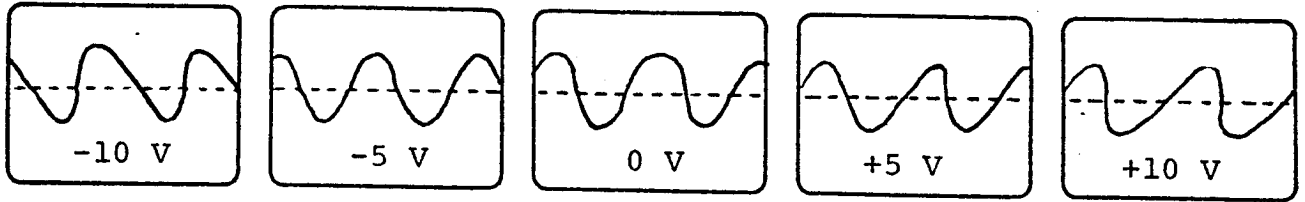

TRIANGLE WAVE

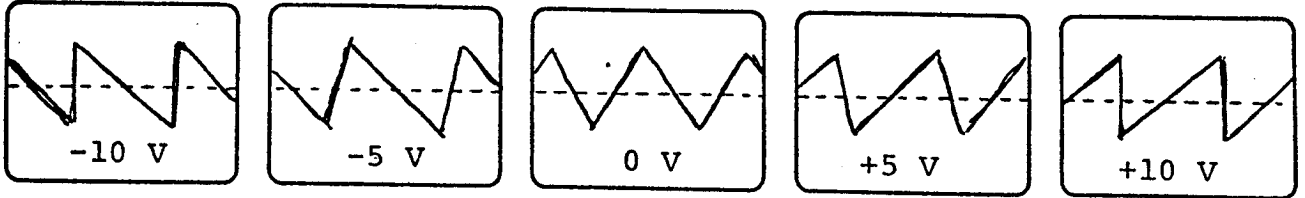

SQUARE WAVE

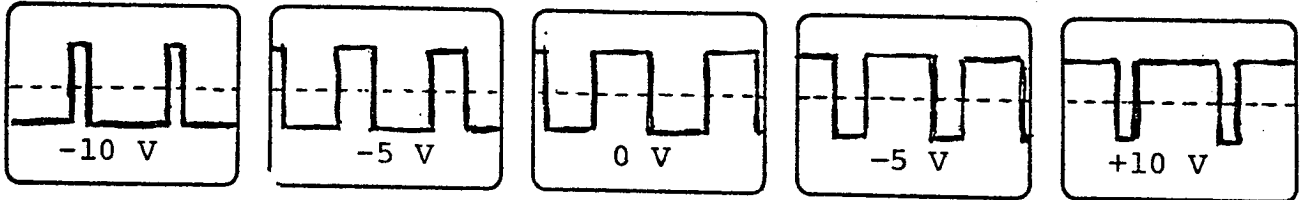

WAVEFORM GENERATOR OUTPUTS (13) There are two OUTPUT JACKS (+) and (-) for each of the three wave forms: sine, triangle and square. These are used to feed out voltages from all WG functions except the two additional outputs for the AM voltages (12) already mentioned above.

For all of these, the choice between positive or negative outputs determines how the waveform will start. Positive voltage starts waves upward. Negative voltage starts waves downward.

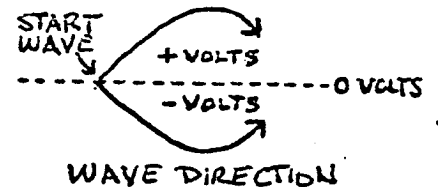

Here's one example of how you might use these alternate starting directions of the same waveform:

ORIGINAL VIDEO IMAGE

ALT. LINE DUPLICATES

IMAGES MOVE IN OPPOSITE DIRECTIONS

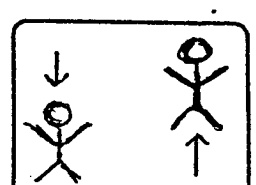
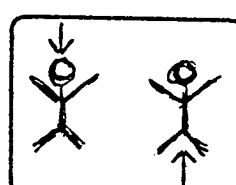
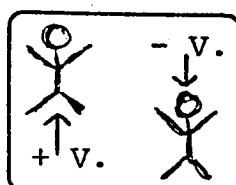
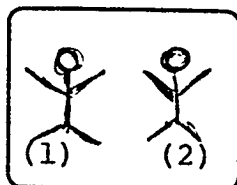
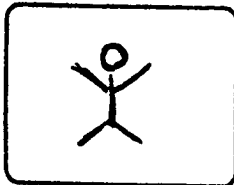

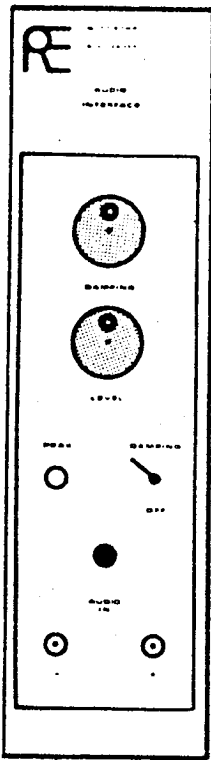

AUDIO INTERFACE

With the AUDIO INTERFACE we create dynamic image transformations acting in concert with such external sources as the sounds of music and speech. This module also accepts the varying voltages output by biophysical and other sensing devices, reflecting the ongoing characteristics of external events.

The AUDIO INTERFACE has two knobs. LEVEL (2) regulates the strength of incoming signals. Adjust this so that the PEAK Indicator (3) lights up only occasionally and then for only a moment at a time.

The DAMPING Knob (1) is active only when the Switch (4) is raised to DAMPING.. When this switch is OFF, the incoming signal is processed in its original form. This latter is often characterized by very wide fluctuations, too rapid or extreme to produce powerful pictorial images.

ORIGINAL SIGNAL:

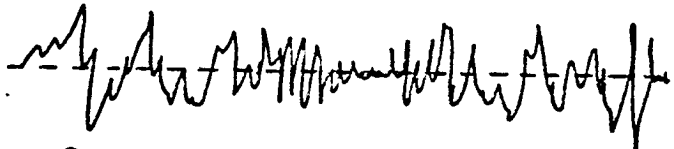

DAMPED SIGNAL:



When switched to DAMPING, the DAMPING Knob increases or decreases the degree of smoothing-out of the extremes and subtleties of a complex signal. The essential dynamic form of the incoming waveforms will still be evident, but their movements will be more coherent and powerful, rather than rapid and jiggly.

Positive and negative voltage OUTPUTS (5) are at the panel bottom.

By way of illustration: Here's a patching diagram which, with appropriate adjustment of the controls involved, would enable you to animate the upper and lower lips (separately controlled by DUAL TRACE division) of a cartoon. Their movement would synchronize with voltage amplitude variations from an amplifier feeding out the sounds of speech.

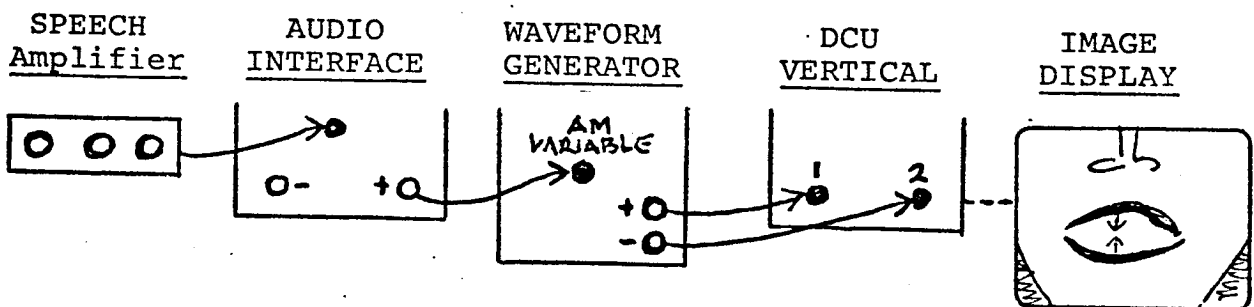

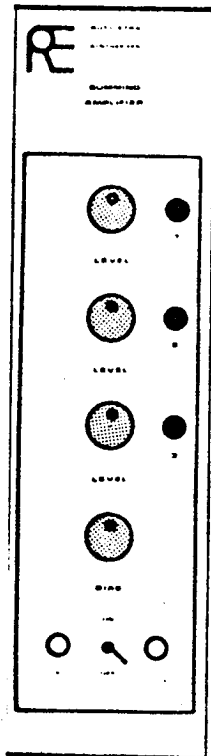

The SUMMING AMPLIFIER mixes the outputs of two or more circuits patched to its INPUTS (#1,2,3). LEVEL Knobs at each Input adjust incoming signal strength, just as do the volume controls on an audio mixer. The BIAS Knob (4) adjusts the summed output fed out from (+) or (-) OUTPUT JACKS (5).

Here's an example of this Module's use:

1. With WG FREQUENCY Switch on "V" and SYNC Knob on FREE RUN, patch (+) WG OUTPUT into SUMMING AMP INPUT 1.
2. Patch (+) RAMP OUTPUT (switch DOWN) into INPUT 2.
3. Patch (+) SUM. AMP OUTPUT into (DCU) HORIZONTAL.

After appropriate tests & adjustments: Move Ramp switch UP to move the image, with waveform undulating its shape, across screen left-to-right. As the image moves toward its stopping point, right-screen, the wave movement gradually diminishes until the image is entirely static.

DIODE MODULE

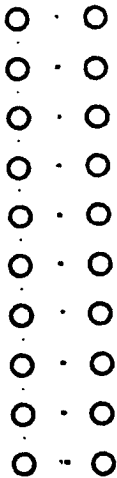

There are ten diodes in the DIODE MODULE.

When a varying voltage, which ranges between positive and negative polarity, is patched to the input on one side of any diode, the output opposite it will deliver only that polarity (+ or -) marked on that output.

This cuts off one of the two different polarities of a polarity-reversing signal. It is useful at times in modifying the image actions motivated by such voltage sources as the Ramp and Waveform Generators, the Audio Interface and the Summing Amplifier.

Here are two situations where the DIODE MODULE is useful:

1. OBJECTIVE: You want a jumping object to stop at ground level and then to jump up again.

This can be accomplished by running a LOW frequency from the AM output of a Waveform Generator through a Diode outputting positive voltage only. This, in turn, is patched into (DCU) VERTICAL. Amplitude of the wave can be adjusted either by the (WG) AM BIAS control or by the appropriate (DCU) LEVEL control for VERTICAL.

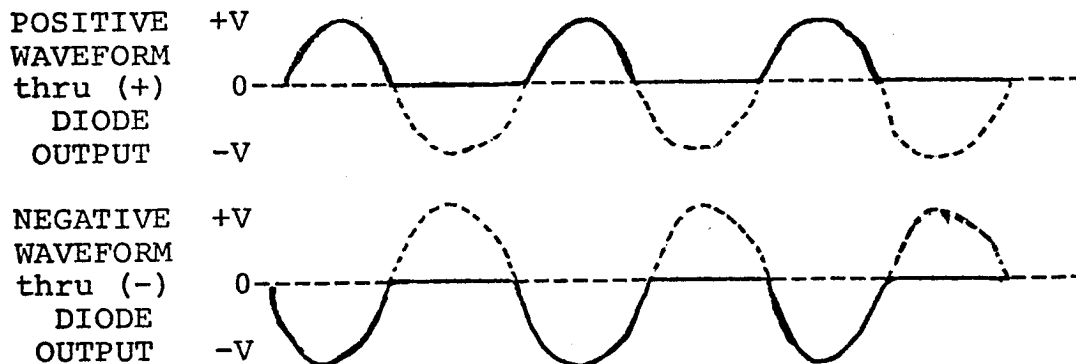

(See next page for 2nd example.)

2. OBJECTIVE: To establish a point in the ascension or descent of voltage from a Ramp Generator, so that its voltage output will automatically switch to a different set of image modifying controls. This, in other words, is a way to switch horses in midstream, to change the mode of animation being caused by Ramp action.

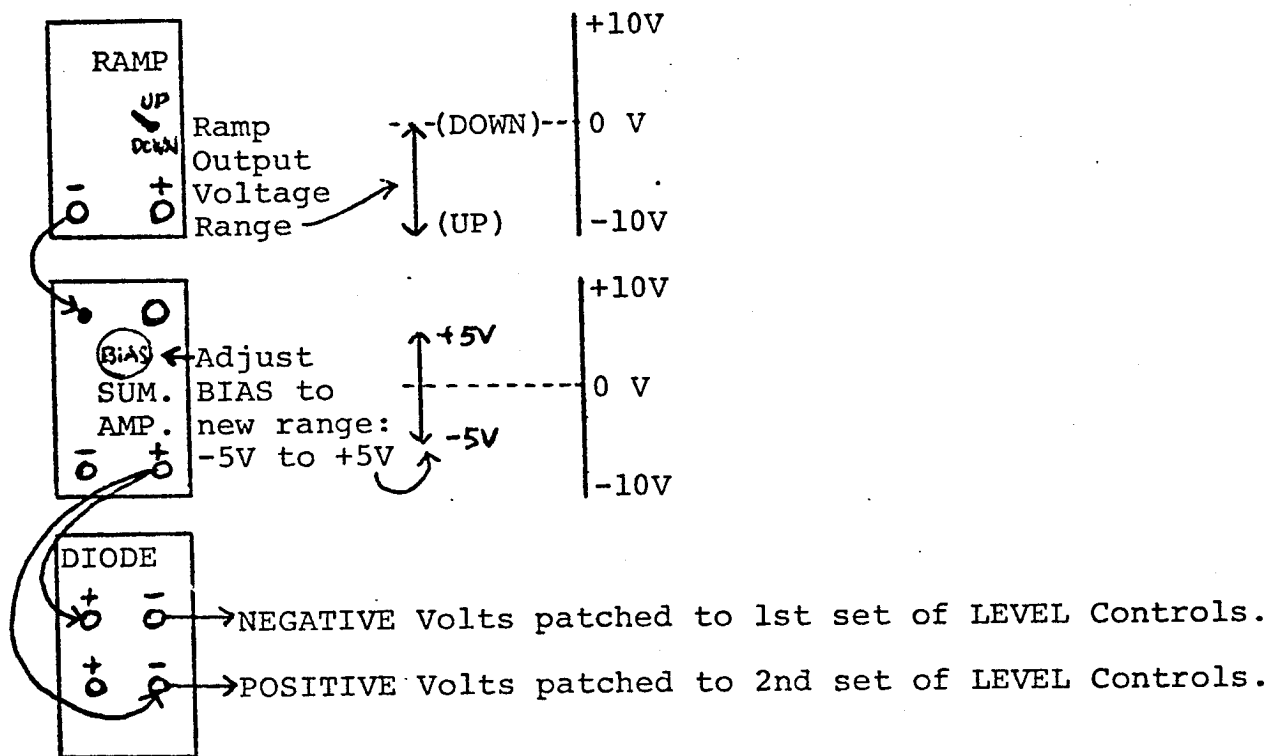

At the point in the ascending or descending RAMP action where polarity changes from negative to positive, or vice-versa, the image animation will be switched automatically from one set of LEVEL controls to a second set of LEVEL controls. In adjusting each set of LEVEL controls, you will, of course, have previously established the settings of their respective BIAS controls.