

cvi COLORADO VIDEO, INCORPORATED • BOX 928 • BOULDER, COLORADO • 80302

Phone (303) 444-3972 • TWX 910-940-3248 (COLO VIDEO BDR)

23 August 1974

Woody Vasulka
Instructional Communication Center
State University of New York
22 Foster A
Buffalo NY 14214

Dear Woody,

Thanks for the interest in CVI instruments. A copy of our complete catalog is enclosed together with extra data sheets on the 606 Video Quantizer series and a note on video feedback. The 606s can easily be modified for external voltage control and are usable with both sound and imagery. Several other instruments in our product line are also useful in the electronic arts.

Sincerely yours,

COLORADO VIDEO, INC.

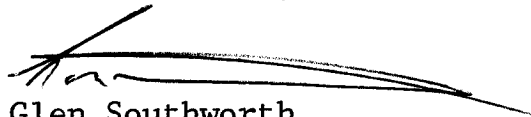

Glen Southworth

GS:pn
Enc.

30 March 1992

Woody Vasulka
Rte #6, Box 100
Santa Fe, NM 87501

Dear Woody,

Enclosed is a funny package of materials related to video art produced by myself and others with Colorado Video equipment. Wish that it was more coherent, but it goes back over 25 years and I didn't keep very good records.

A few historical notes:

1966 - model 201 video to computer converter (1 bit greyscale)

- model 401 Video X-Y Plotter (accepts wide range of data rates and converts to TV format)

1969 - model 606 Video quantizer

By rough count we've designed over 40 instruments that involve video image manipulation, storage, or transmission (that's a collective "we", by the way.)

If you really want it, I'll try to organize more detailed information and generate a Southworth video art bio, though, as I mentioned, I'm more of a technician than an artist.

Hope that things will go very well with your project. I'd like to visit you and Steina this summer if I get a chance.

Best regards,



Glen Southworth

P.S. Unfortunately all of the old CVI equipment seems to be gone. *
I do have a personal model 274D that I might let you have.

* except for some slow-scan equipment.

21. Patty Nettles - "Video Art: New Visions"
- ~~22. Wyndham Hannaway - Second cover art, PHOTOMETHODS ?~~
23. Wyndham Hannaway - poster
24. M.I.T. - hard copy of video art slow-scan TV transmission
25. M.I.T. Visible Language Workshop - Program for TRANSMIT 1983
- ~~26. Artist unknown - cover of Modern Electronics, June 1978~~
27. Eric Morey et al - Metacolor brochure (composite 606 and photographic techniques)
28. Metacolor - Services & price list
29. Glen Southworth - Self portrait with first experiments on direct CRT copying with original XEROX color machine
30. John Fitzgerald - portrait of woman made directly with XEROX color copier (equipment: TV camera, disc frame grabber, 606, sequencer, and XEROX machine)
NOTE: John was the originator of this concept.
31. Metacolor - Video art client list as of January 1977
32. Norman Southworth - Abstract image (493 peak store & 606)
33. Metacolor - "lips" (35mm slide from 606 image)
34. Glen Southworth - 35mm slide of same
35. Glen Southworth - short resume
36. Glen Southworth - self portrait with original 606
37. Glen Southworth - U. S. Patent #4,713,693
38. Colorado Video - photograph of early computer portrait system
39. VIDEOTAPE: Patty Nettles & Mark Peterson - "WARP FIVE"

video frame store 274 c/d

general description

The Model 274C Video Frame Store is a solid state memory with high speed A/D and D/A converters, and is capable of digitizing, storing, and displaying a single frame of video information.

The "frame grab" process can be initiated by means of a front panel pushbutton, remote pushbutton, or TTL compatible convert signal. The unit digitizes and stores the first frame following the conclusion of a convert command. The video output is a standard video signal synchronized to the video input and can be switched or mixed with other video signals or recorded on conventional video tape recorders.

A digital I/O option is available that allows individual picture elements in the stored image to be accessed by a computer, processed, and returned to the Model 274C memory. This I/O option can easily be interfaced with most computers or other digital processing equipment. A single 16-bit duplex I/O module in the computer is all that is required for interfacing to modern mini-computers. All digital signals to or from the unit are buffered and are TTL compatible.

With the 274D option, front panel switches modify the video display and allow any or all of the gray scale components to be selected or deleted for posterization effects. Resolution of the frozen image is also variable in steps down to 16 x 16 blocks.

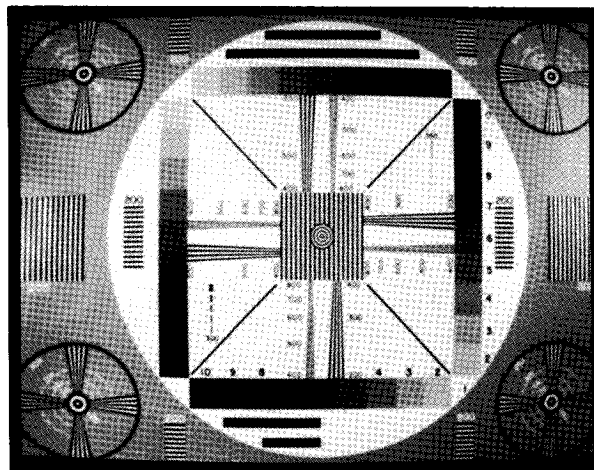

512 x 512 x 8 BIT IMAGE

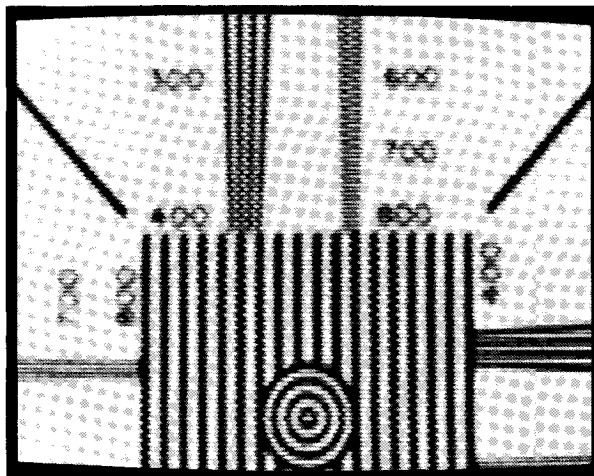

DETAIL OF ABOVE PICTURE

specifications

Size:	10½" x 19" x 15"
Weight:	30 lbs.
Mounting:	Standard 19" rack
Construction:	Solid state, card file
Power:	117 VAC, 60 Hertz, single phase, 100 watts
Input/Video:	Composite video; 1 V p-p, 75 ohms
Input/Control:	Store: Pulse, ground true, 1 μs min. or switch closure to ground
Output/Video:	Composite video; 1 V p-p, 75 ohms
Controls:	AC power: On/Off Store (can be remotod) Video Level Black Level
Indicators:	AC Power

performance

Resolution:	Full resolution (frame store) 512 x 512 picture elements, dot interlaced; TV test chart resolution is 500 lines. Medium resolution (frame store) 256 x 512 picture elements, repeats same data in both fields; TV test chart resolution is 270 horizontal lines. Low resolution (field store) 256 x 256 picture elements, repeats same data in both fields; TV test chart resolution is 135 lines.
Frame Store Time:	1/30th second
Grayscale:	Standard: 8 bits (256 gray levels) Options: 1 bit through 7 bits

options

• Direct Memory Access Digital I/O Module 723

Inputs/Digital:	Strobe Read/Write Latch/Operate Line/Column Starting Address X or Y Data (starting X, starting Y, Z)
------------------------	---

Outputs/Digital:	Status Z Data
-------------------------	------------------

Frame Time: (minimum)	Full resolution: 2.1 sec. (512x512) Medium resolution: 1.05 sec. (256x512 or 512x256) Low resolution: .525 sec. (256x256)
---------------------------------	---

• 274D

Has the same specifications as the 274C, plus the following front panel controls which affect the display only:

Grayscale: On/Off
1,2,3,4,5,6,7,8

Resolution: 16, 32, 64, 128,
256, 512

• NTSC COLOR

Color freeze capability is available in both the 274C and 274D.

SPECIFICATIONS SUBJECT TO CHANGE WITHOUT NOTICE.

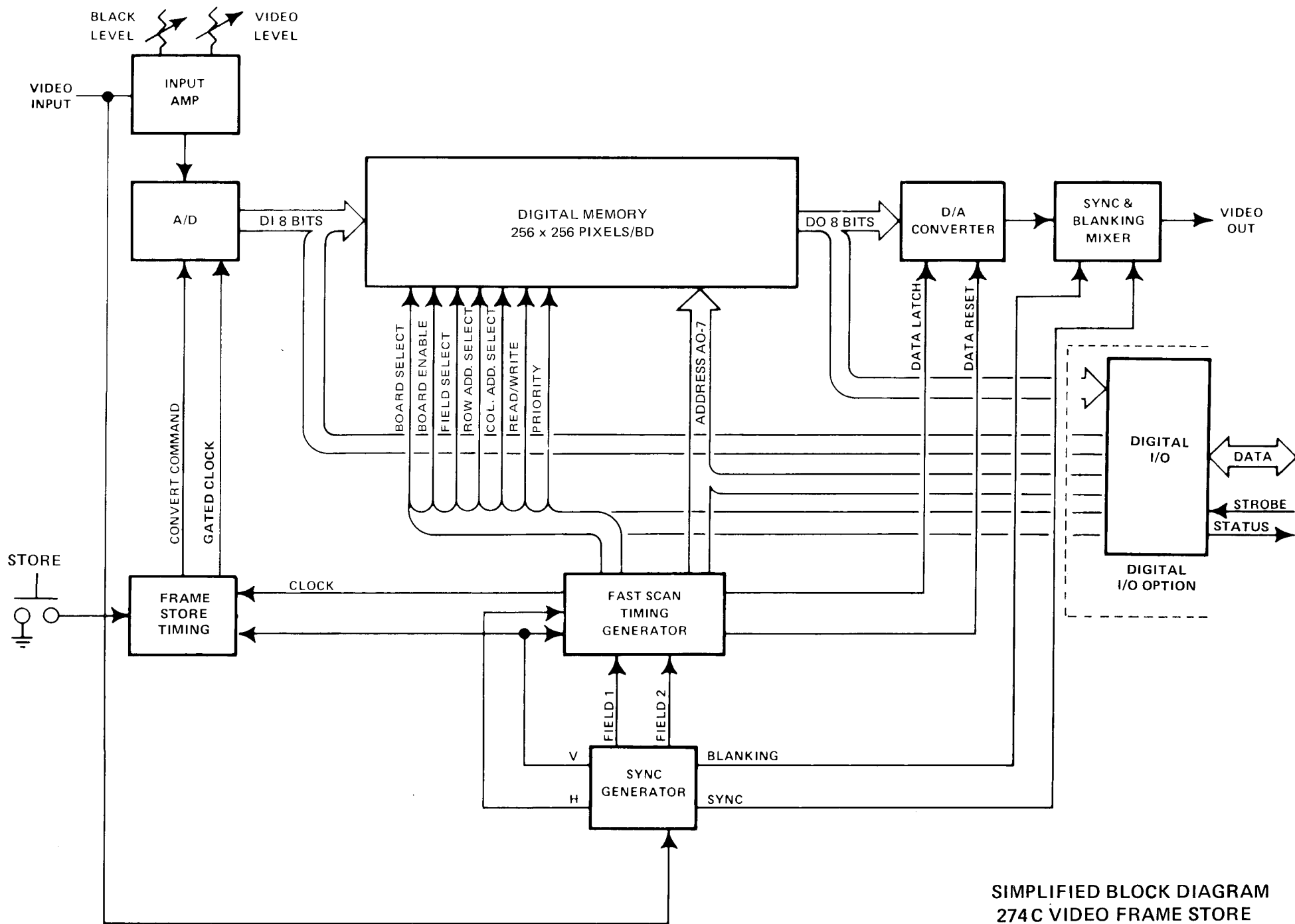

SIMPLIFIED BLOCK DIAGRAM
274C VIDEO FRAME STORE

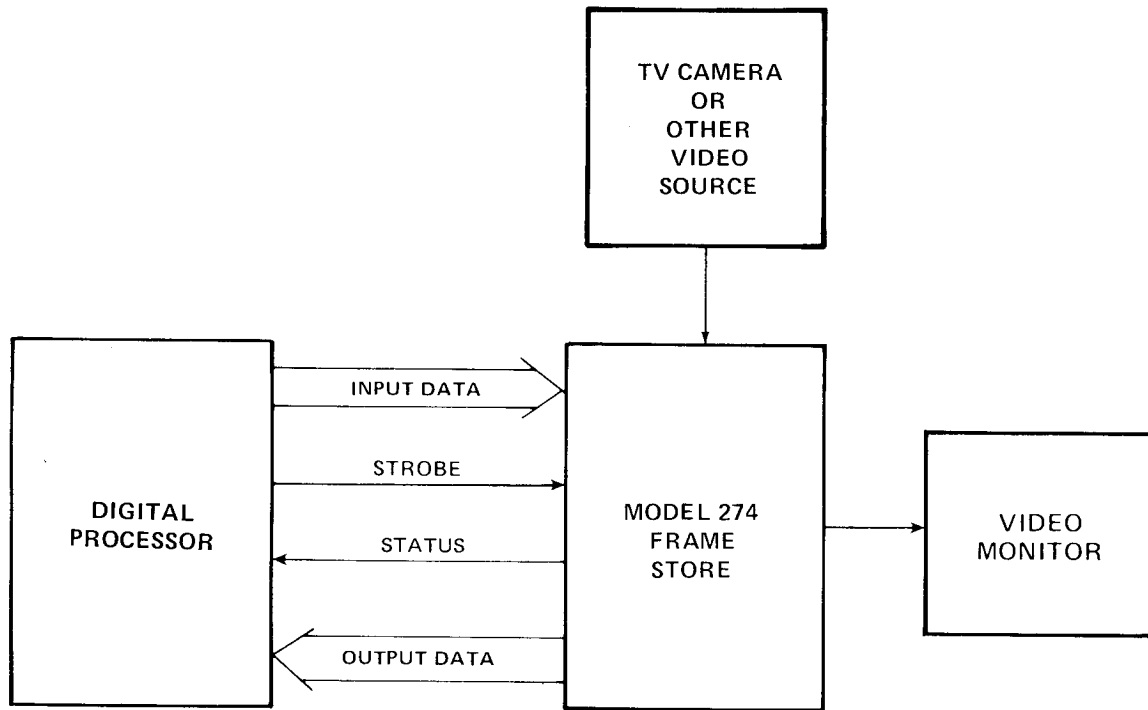

TYPICAL FRAME STORE/DIGITAL PROCESSOR SYSTEM

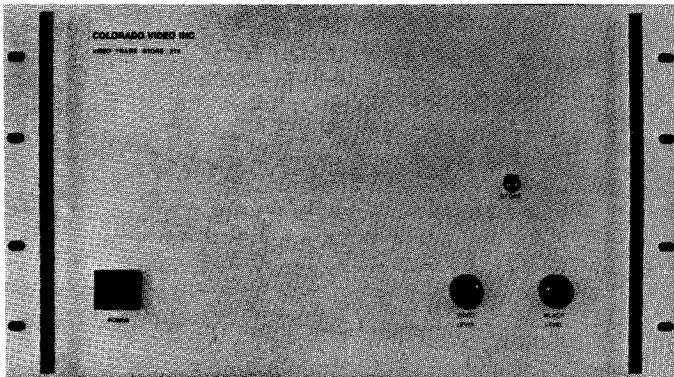

VIDEO FRAME STORE 274C

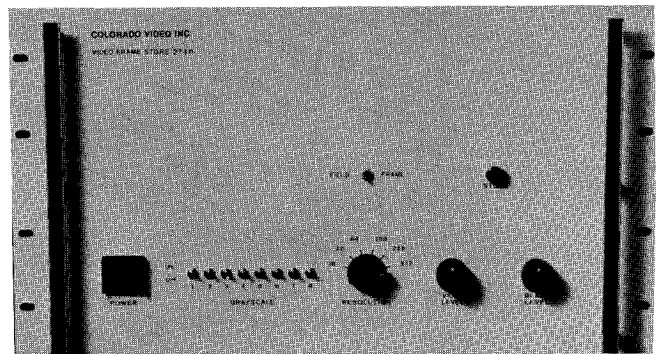

VIDEO FRAME STORE 274D

REPRINTED FROM

IT IMAGING TECHNOLOGY

IN RESEARCH & DEVELOPMENT

MAY 1984



DIGITAL PHOTOGRAPHY

GLEN SOUTHWORTH

Solid state video memory has served as the basis for "instant" electronic imaging in science and industry

DIGITAL PHOTOGRAPHY

GLEN SOUTHWORTH

Imagine paying five to ten thousand dollars for a single sheet of film! That's what a solid-state video memory might cost you, and the TV camera and monitor to go with it can add substantially to the price tag. Furthermore, the resolution of your piece of "electronic" film isn't all that great, perhaps being somewhat comparable to a 16mm frame.

Now for the advantages: First, how about really fast development? One thirtieth of a second and no chemicals to fuss with or replenish. Second, your "film" is reusable and good for a few million shots without deterioration. Of course there's no need for a darkroom, and instant enlargements are available by means of a 25" TV monitor or video projector. Don't worry about H&D curves, as the video memory is highly linear (although the TV camera may not be). No "grain," as such (though the TV camera may introduce the equivalent.) Color? Sure, either a single encoded image from a standard color TV camera, or separate Red-Green-Blue image planes for greater flexibility in signal handling and higher resolution.

A few words about television cameras. These come in a surprising variety of configurations with prices ranging from \$100 or so to over \$100,000. Sensitivity can range from the equivalent of ASA 25 to somewhere in the neighborhood of ASA one million for a "starlight" camera. Special tubes, such as the Pyricon, allow viewing in the infrared region of the spectrum and others are sensitive to ultraviolet or X-ray radiation. There are, of course, limitations on TV camera performance as a data acquisition device, and these will be touched upon later.

Let's get down to cases. One common

use of instrumentation photography is to freeze transient phenomena for subsequent observation and analysis. Figure 1 shows a simple block diagram of a video system capable of doing this, with major components being a television camera, solid-state video memory, and a TV monitor. Also shown are two other potentially very important elements, a mechanical shutter (for daylight use) and a high-intensity pulsed light source (for use under other lighting situations). The reason for these last two factors is graphically shown in Figure 2 and is based upon the fact that during normal operation the TV camera acts as if it were taking a $\frac{1}{30}$ second exposure, which of course is far too slow to give a clear image of a rapidly moving subject.

If a subject is temporarily stationary, the image capture is as simple as pushing a button. For the equivalent of short exposure times implementation becomes more complex and some of the considerations involved in two general cases will be outlined.

A. Daylight or other relatively strong, continuous illumination of the subject. In this instance a mechanical shutter may be

used to reduce the equivalent exposure time of the TV camera tube. This may be achieved through use of a narrow slit in an opaque disc that is synchronously rotated in front of the TV camera tube providing approximately the equivalent of a focal plane shutter.

B. A controllable lighting situation may make a pulsed light source preferable, and exposure times of a few microseconds are obtainable. Note, however, that for best results the short-duration light source should be fired during the vertical retrace period of time when the camera tube is not being actively scanned.

In both of the above examples, a further complication arises in that conventional TV cameras use interlaced scanning, and a complete frame is composed of two separate fields, each of $\frac{1}{60}$ second duration. A

Glen Southworth is president of Colorado Video Inc. Previously a project engineer in the digital television department at Ball Brothers Research, Boulder, and chief engineer of radio and television services at Washington State University, he is an inventor and author with more than 30 years experience in the electronic imaging field.

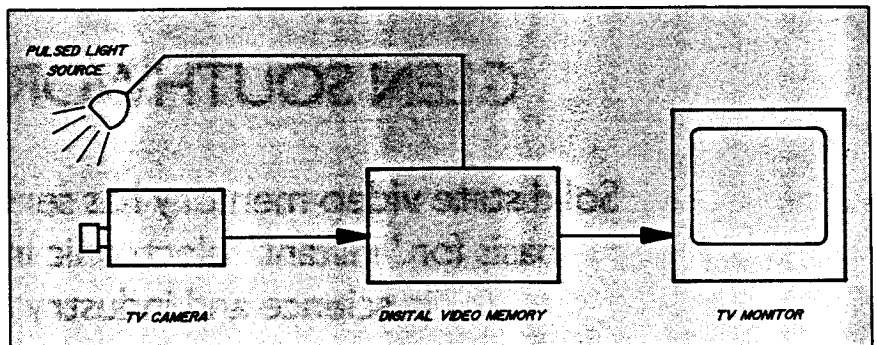

Figure 1. Block diagram of typical digital video memory set-up.

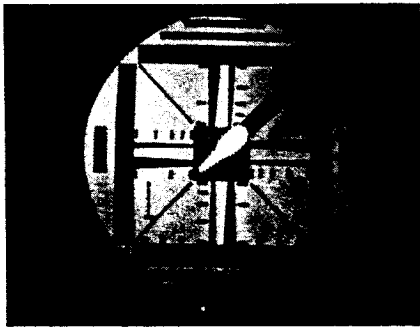
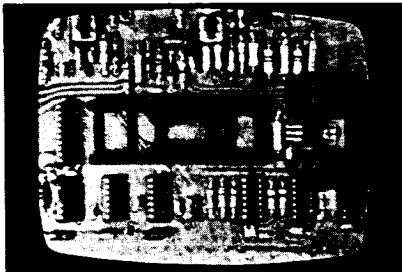
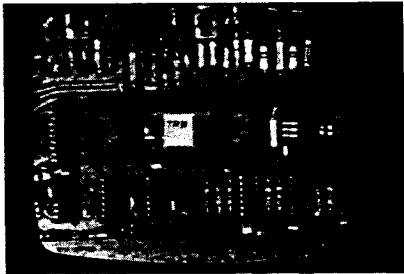

Figure 2. Example of increase in camera tube sensitivity achieved by integration. Scanning beam of a silicon target tube was turned off for a period of 4 seconds, then turned back on, and the resulting video data transferred to a digital memory in the next 1/60 second. Near infrared radiation from the soldering iron was then sufficient to illuminate the test pattern.



A



B

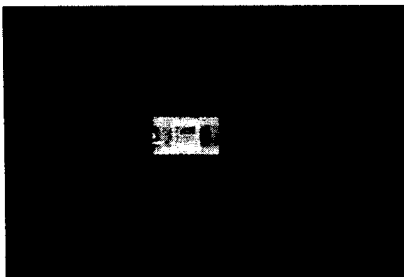

C

Figure 3. Off-screen photos showing: A. A normal circuit board; B. The same circuit board with a part missing; C. The combined outputs of two digital video memories, one of which is subtracted from the other, leaving an image of the missing part plainly visible.

single exposure from either shuttered or pulsed light source will generally cause the first field after the exposure to be read out at full amplitude, but the second field may be substantially degraded and the combination of the two fields may result in a flickering image on the TV screen. The simplest solu-



Figure 4. Flight patterns of birds. A 20-minute, daylight time exposure using a peak store video memory and an inverted video input.

tion is to store the first field only, and sacrifice half of the vertical resolution in the picture. Alternately, TV cameras may be operated at 30 or 60 frames per second in a noninterlaced mode and either recorded in memory in that fashion or converted by the memory into an interlaced format.

Timing is a critical factor in transferring information from the TV camera tube to the solid-state memory, and it is best to have the TV system itself control shuttered or pulsed lighting. In some instances, such as the capture of random events, this is not practical, and more complex approaches may be employed such as temporarily interrupting the camera tube scanning process before the occurrence of an event. The target of the camera tube can make an excellent short-term storage device and retain information for several seconds (depending upon the specific tube used) if not scanned.

The application of image freezing for the observation of transient phenomena is obvious, but it can also be highly useful in some instances when the subject is not moving in a spatial sense. One example of this is in high-power microscopy where a small amount of mechanical vibration may render an image useless to the observer. The same can hold true in telescopic observations, which may be complicated by atmospheric perturbations. In either case, a frozen image may provide superior interpretability.

If you are looking for supersensitivity, take a time exposure with the TV camera. The target of the camera tube will continue to integrate light falling on it as long as it is not discharged by the scanning beam. After a predetermined period of time scanning, the process may be initiated and the resultant data fed into a video memory. Note that the readout is destructive, and the first field will have the best quality image, although it may take several scan repetitions to completely erase the charge pattern on the target. An example of a TV time exposure is shown in Figure 3, where the sensitivity of a camera employing a silicon diode tube has been increased by a factor of nearly 30 and thus provides sufficient response in the near infrared for a soldering iron to effectively illuminate a test pattern.

A note of caution. The amount of sensitivity increase obtainable will depend upon

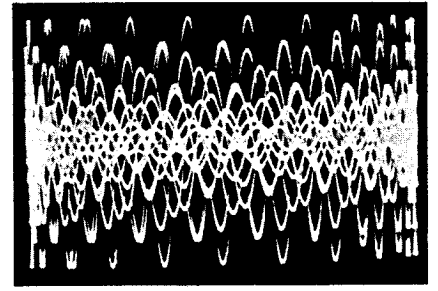

Figure 5. Example of electro-optical scan conversion using a TV camera focused on the screen of an oscilloscope and using a peak store memory for long-term storage.

several factors such as the type of TV camera tube target and the temperature of the target. Also, some modifications to the video amplifier in the camera may be desirable for optimum performance.

Additional advantages can result from the use of two or more memories. First, let's take the matter of making comparisons. Figures 3A and 3B show two identical pictures of a circuit board with a component missing in one. By electronically switching back and forth between two memories, and looking at the results on a single TV monitor, you will see the missing part seem to blink on and off. An even more interesting way of viewing changes is to electronically convert the output of one of the memories into a negative image and then combine the signal with that of the noninverted memory. The result is shown in Figure 3C and is not only visually striking, but easy to automatically detect on a production line.

Both "blink" and subtraction have their counterparts in the film world, but are much more readily accomplished digitally. In addition, the subtraction process may be electronically accomplished in real time with a reference image frozen and a digitized image subtracted at the TV camera frame rate of 30 times per second. It's a technique that works well for intrusion detection or observation of other transient anomalies.

The use of three video memories suggests color. Consider the advantages of having individual control over each of the Red, Green and Blue components of a picture. Again, virtually instant response as you adjust a knob, the ability to separately adjust brightness as well as contrast, and even to affect the gamma of each channel, or to produce masking effects by feeding negative signals from one channel back into another.

Color input signals may be derived from a three-tube color TV camera which has separate R-G-B outputs available, or may be obtained by sequentially recording the output of a monochrome camera with appropriate filters placed in front of the lens or the tube face. The latter approach opens up some fascinating possibilities in research applications. For example, the use of supersensitive single-tube cameras (or employing the integration technique mentioned earlier) to

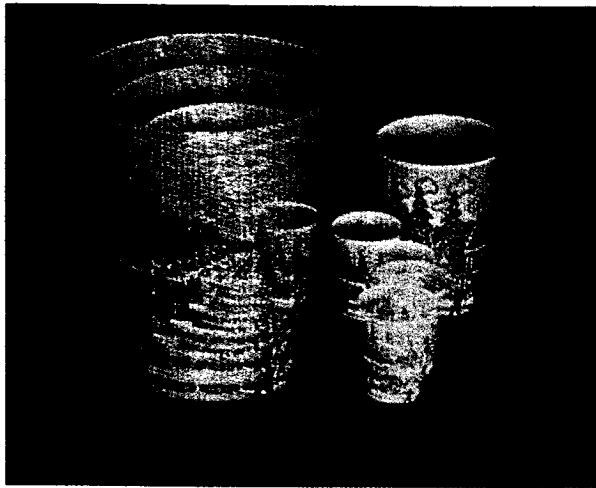

Figure 6. Multiple image build-up using a peak store memory (original stored image was in NTSC color).



Figure 7. Dual portrait using a peak store memory and a flashlight as a "planning" source.

obtain color pictures under low-light-level conditions. Spectral translation may also be accomplished by use of three narrow filters in a particular region of the visible spectrum such as the deep red, and the outputs of the three video memories reproduced as Red, Green and Blue. Alternately, components in the near infrared, visible light, and ultraviolet might be combined, or a color composite made by using X-rays at different voltages and corresponding variations in penetrating power. Changes in the polarization of a light source, variations in depth of field, and a host of other monochromatic image manipulations may be translated into arbitrary color images, some of which might turn out to be highly meaningful.

Next, let's look at an unusual form of digital video memory that seems to have no counterpart in the field of chemical photography. The special characteristic in this case is making time exposures, not only over a period of time, but in broad daylight. The trick is to make electronic comparisons between succeeding frames of information and add to the original stored image only new information which is brighter (or darker) than previously stored data. The results are fascinating. Want to capture summer-time lightning-stroke patterns? Just point the TV camera at the horizon, adjust the camera iris so that the brightest flash won't overload the video amplifier, and sit back. Whether your "exposure" is one second or five hours should make little difference. Interested in the local aircraft flight patterns or the movement of birds? This time just invert the video input polarity to get a negative image and watch the video monitor screen fill with tracks as shown in Figure 4.

The peak storing video memory also works nicely in the laboratory for the recording of transient events, and can be very useful in conjunction with the conventional oscilloscope for viewing of either very fast or very slow patterns. The room lights need not be turned off, but reflections from the CRT faceplate should be avoided. Note,

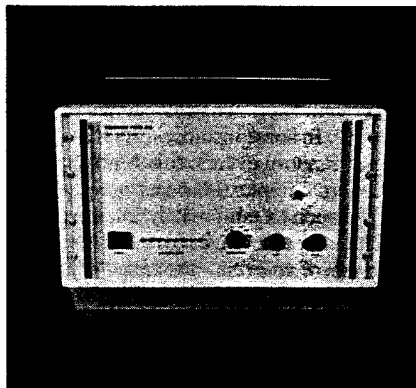

Figure 8. Typical solid-state digital video memory with computer I/O capability; Colorado Video Model 274D.

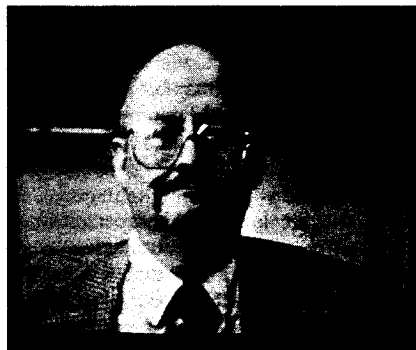

Figure 9. Off-screen photo of author.

too, that the TV camera tube, being an integrating device, will be sensitive to variations in the CRT scanning beam velocity.

For the artist, the peak store memory allows the production of some striking special effects, such as zooming, creation of composite images, and "painting with light," examples of which are shown in the accompanying illustrations. A very little known technique, even among video experts, the peak store memory almost seems like the classic case of a solution looking for a problem.

Computers. The fact that our electronic images are in digital form makes it practical to connect to a computer for useful tasks in image measurement and analysis. Video densitometry? Histograms? Area measurements? Just use the right program. Likewise with height, width, position, interval, angle, size curve or other geometric characteristics. Pattern recognition? Of course. The field of image processing by computer is worth a shelf of books by itself, and even small personal computers have enough power to perform many functions.

Finally, a slight problem with "reusable" pieces of electronic film. How to save that important data from an experiment or observation, particularly as the image goes away when the power is turned off. It's easy to fall back to old, reliable, chemical film and shoot pictures from the TV screen for a permanent collection, or maybe you'd prefer to use a videotape recorder for storage (again, it's a reusable medium). If you're looking for a really elegant form of storage or archiving, use the computer to record data on floppy or hard discs. The accuracy is superb; no loss in resolution and no gray scale deterioration. If you're in a hurry to share your findings with colleagues, the computer formatted pictures may be transmitted over phone lines to the far corners of the earth. ■

References

- Bernal, E.G. and Loomis, John. "Interactive Video Image Digitizer-Application to Interferogram Analysis." *SPIE-Clever Optics* Vol. 126 (1977).
- Southworth, Glen R. "Computers in Optical Systems: Data Extraction from CCTV Signals." Vol. 148: *Proceedings of the Society of Photo-Optical Instrumentation Engineers*. 1978.
- Southworth, Glen R. "The TV Camera As a Computer Input." *EE/Systems Engineering Today* July 1973.
- Sparks, John. "Television That Nobody Watches." *Machine Design*, February 1972.

video frame store 274

general description

The Model 274 Video Frame Store is a solid state memory with high speed A/D and D/A converters, and is capable of digitizing, storing, and displaying a single frame of video information. Individual picture elements in the stored picture can then be randomly accessed by a computer, processed, and returned to the Model 274 memory.

The "frame grab" process can be initiated by means of a front panel pushbutton, remote pushbutton, or TTL compatible convert signal. The unit digitizes and stores the first frame following the conclusion of a convert command. The video output is a standard video signal synchronized to the video input and can be switched or mixed with other video signals or recorded on conventional video tape recorders.

The Model 274 can be easily interfaced with most computers or other digital processing equipment. A single 16-bit duplex I/O module in the computer is all that is required for interfacing to modern minicomputers. All digital signals to or from the unit are buffered and are TTL compatible.

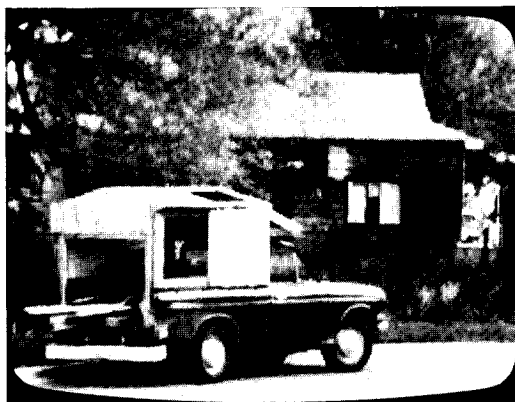

256 x 256 x 6-BIT IMAGE



64 x 64 x 6-BIT IMAGE

inc
video
colorado

- Hot Shot Prod
near Capital Bld.

- Gateway electronics
458 5444

- Servos:
Licity

- Francis Horeng
Los Alamos
Frank Windherr

492-8052
492-7903
200

733-8158 Gordon Gull

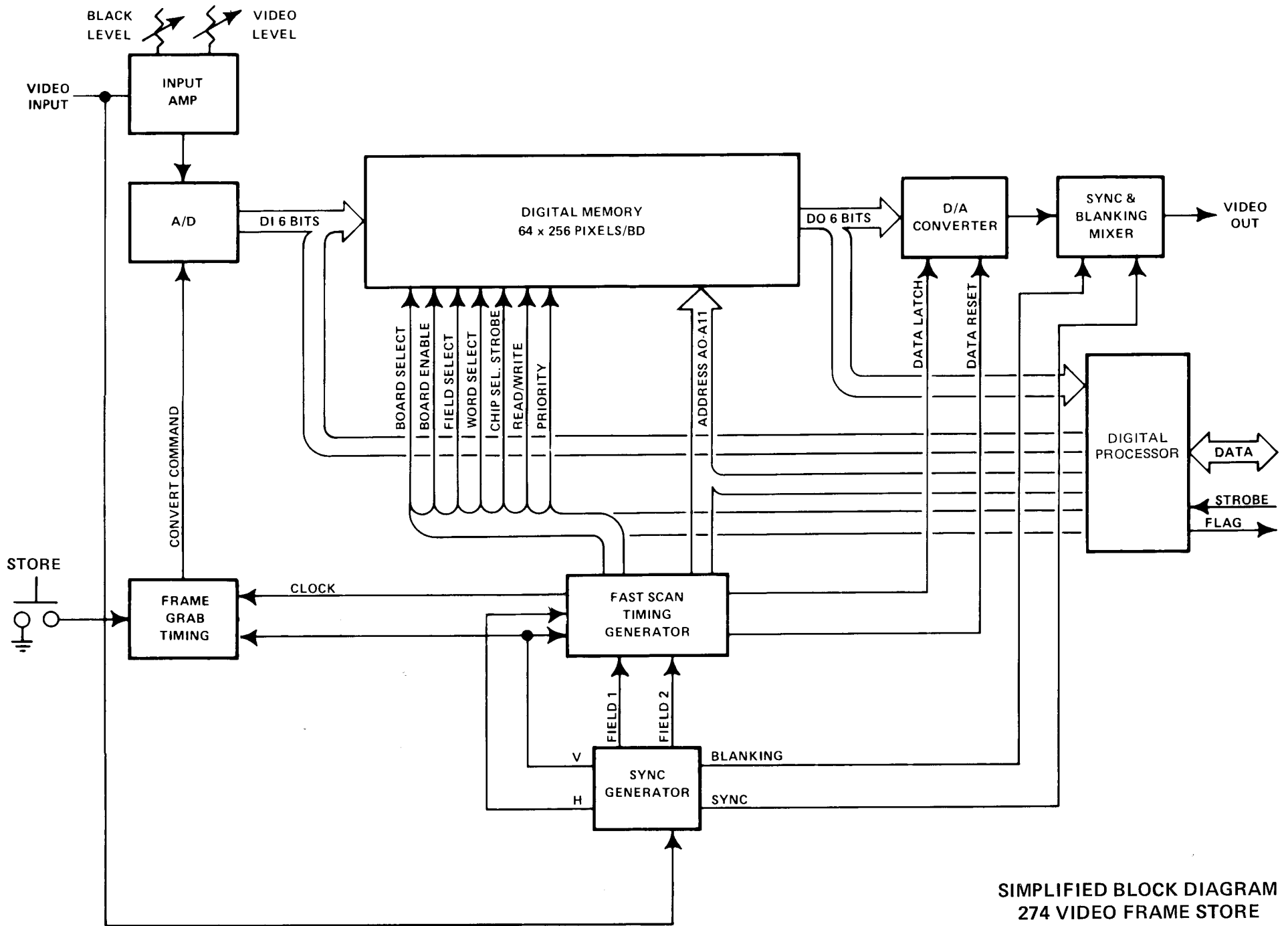

SIMPLIFIED BLOCK DIAGRAM
274 VIDEO FRAME STORE

specifications

- Size:** 10½" x 19" x 15"
- Weight:** 30 lbs.
- Mounting:** Standard 19" rack
- Construction:** Solid state, card file
- Power:** 117 VAC, 60 Hertz, single phase, 100 watts
- Inputs/Video:** Composite video; 1 V p-p, 75 ohms
- Inputs/Digital:** Strobe: True pulse, 1 us min, initiates Latch/Operate cycle

16-bit word: suggested word format:

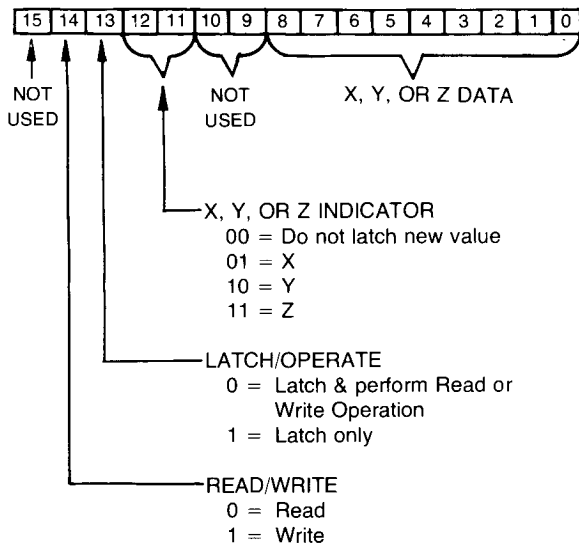

Store: Pulse, ground true, 1 us min.

- Outputs/Video:** Composite video; 1 V p-p, 75 ohms
- Outputs/Digital:** 16-bit word: Suggested word format
Bits 0-7: Video data out
Bits 8-15: Not used
Status (Flag): 0 = Busy
1 = Ready
- Controls:** AC power: On/Off
Store (can be remoted)
Video Level
Black Level
- Indicators:** AC Power

performance

- Resolution:** Full resolution (frame store)
256 x 512 picture elements, dot interlaced;
TV test chart resolution is 270 lines.
Medium resolution (field store)
256 x 256 picture elements; repeats same data in both fields; TV test chart resolution is 135 lines.
- Frame Time:** Frame grab: 1/30 second
Computer I/O: 8.5 seconds for full resolution
4.25 seconds for medium resolution
(Access time: 63.5 us/pixel max.)
- Grayscale:** Standard: 6-bits (64 gray levels)
Options: 1-bit through 8-bits

options

220 VAC, 50 Hertz power input and 625-line TV output.
Digital processor I/O can be omitted.

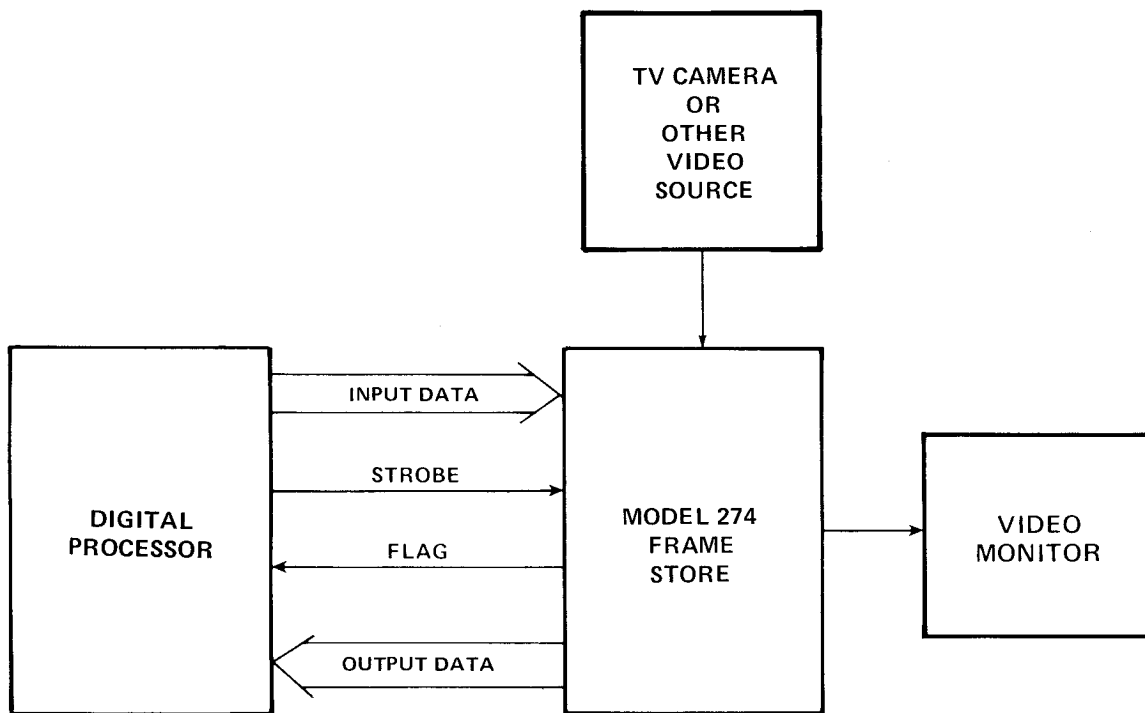

TYPICAL FRAME STORE/DIGITAL PROCESSOR SYSTEM

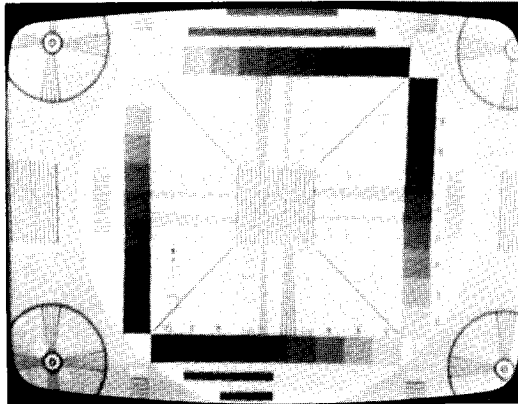

256 x 512 x 6-BIT IMAGE

