

EXPERIMENTAL TELEVISION CENTER LTD.

164 COURT ST.

BINGHAMTON NEW YORK 13901

607-723-9509

4/15/75.

Woody & Arina.

Letter sent to Richard & dub ~~made~~ (I'm sending it COB. tomorrow).

After May 5/6/7 Nuts & Notts I'd like to see what's available on campus — interest in programming for Electronic Arts — computer systems — etc.

Students seem interested!

Very busy here David's cleaning up his colorizer; Don's building 25MHz clocks, I shot a portapak tape last weekend (also some rolls of super 8 & a roll of 35mm b/w's — I'm diversifying).

See you May 5 at 8:00 for the \$8⁰⁰.

Walter.

8/12/74.

Ai Vasulkas.

I'm buying an Intel 8080 microprocessor system w/ CPU, IO module, 2K ROM, 8K RAM, chassis, motherboard & software.

In exchange for software development Rutt will give me some hardware.

And Canada Council is paying for Dave Jones to develop a colorizer.

That's a complete hybrid video synthesizer.

How's Dr. O'Grady coming w/ the National Endowment?

See you in September?

Walter.

Oct 26, 1975

Woody & Siena ;

I too am having trouble with Immigration & need letters of recommendation. A letter of support describing my unique abilities (artist / computer programmer) & experience (worked with most video animation systems & assisted in their design & development).

This letter should be addressed to Ralph ; the ETC is acting as my sponsor.

I'm enclosing a brochure for Synergism, a performance group Gary & I put together this summer.

I think Media Study can have the synthesizer workshop alone for ~\$150.00. Art Park would be an ideal gig - How do we apply?

Walter Wright ☺

September 5, '76

VASULKAS, Woody & Stina .
257 Franklin St
Buffalo, NY, 14202

Hi Folks -

I'm back in Binghamton ~~now~~, returned from Michigan a week ago or so. (Grand Valley State Colleges).

Broke again after pooling my money with Susan for a brand new portapak! However I'm working with Ralph on the computer project. Finally the money for the LSI-11 came through. If we can find Don McArthur we'll be all set?

Thanks for sending your tapes to Grand Valley - I have another favor to ask. Please fill out the enclosed letter of appraisal (lie if you must) for the Canada Council. It's an insurance policy for next year and besides I'd like to travel.

I'd like to travel to Buffalo ~~to~~ show you some new tapes.

Oh well -

Love Walter.

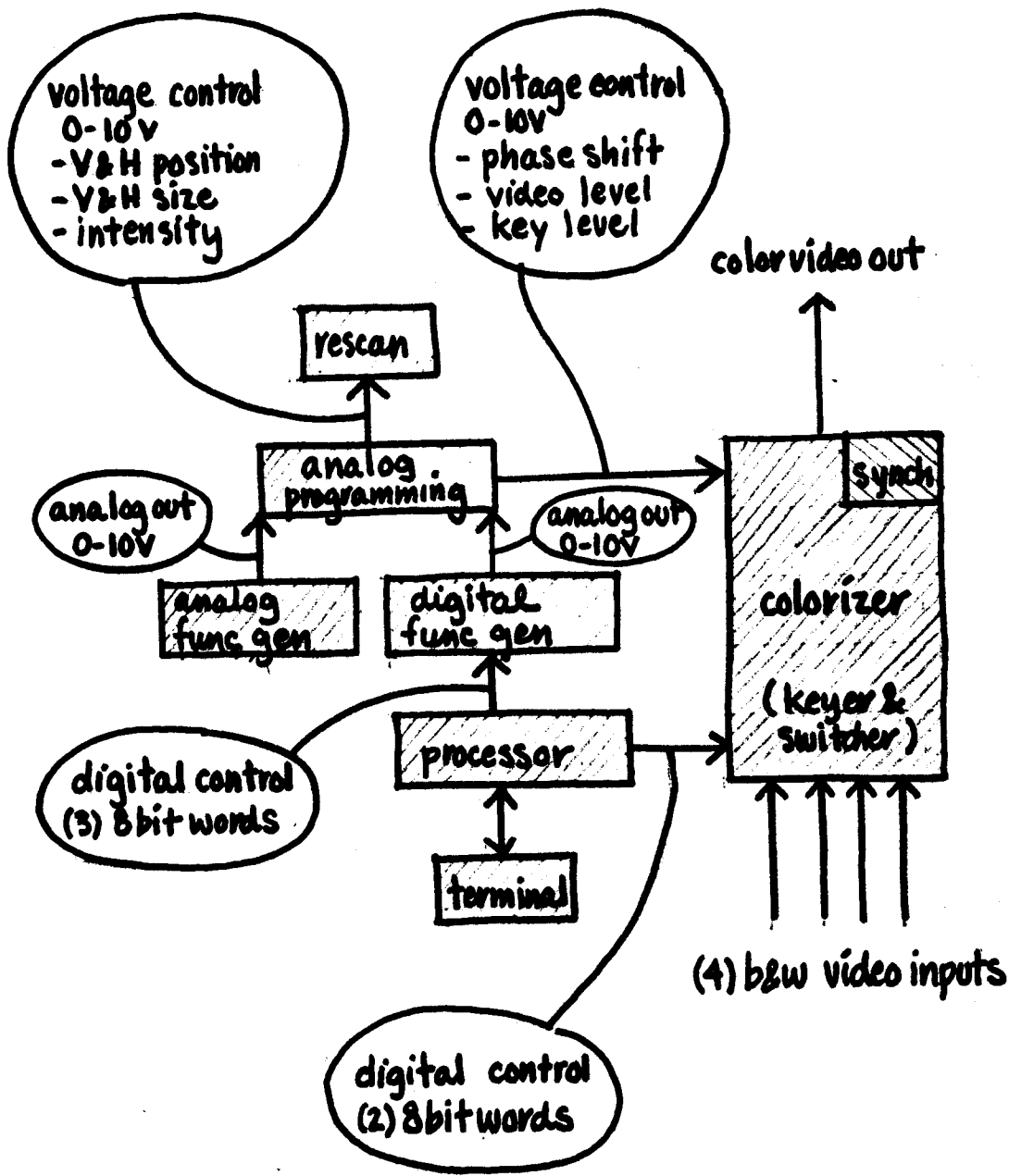

Digital Function Generators.

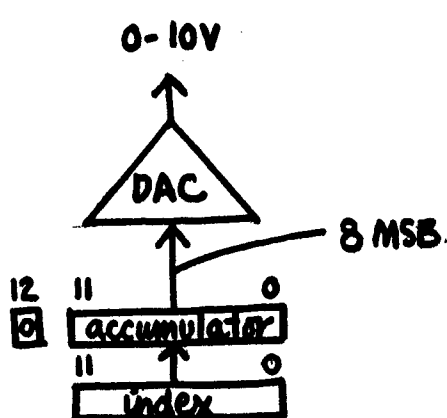

60 Hz clock.

halt - inhibit clock
load A/I

overflow high - halt/continue,
continue invert output.

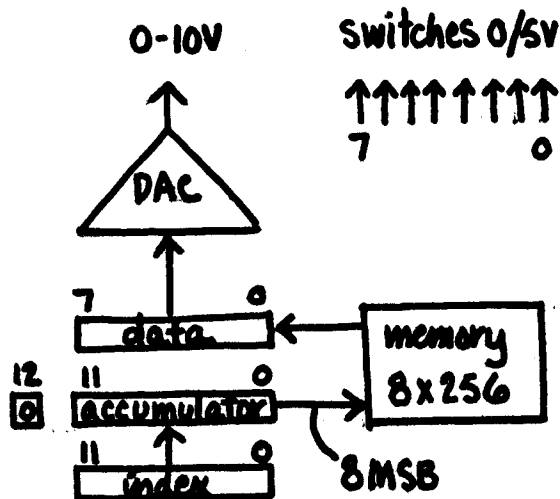

processor input

- word (1) 'FFFF IIII' generator, MSB index
- (2) 'IIII IIII' LSB index
- (3) 'BBBBBBBB' MSB accumulator.

Analog Function Generators

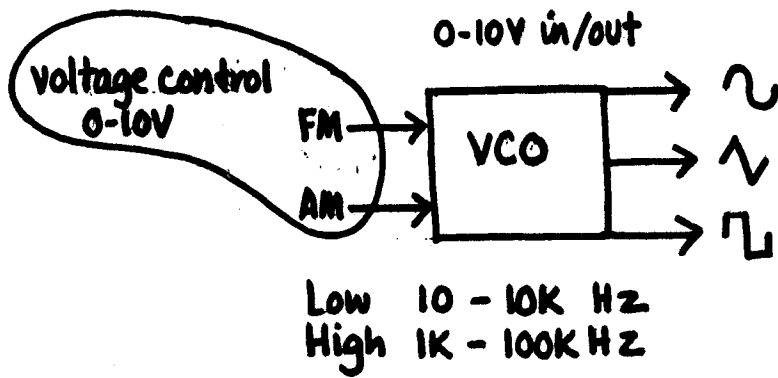

phase lock V&H synch

Analog Programming

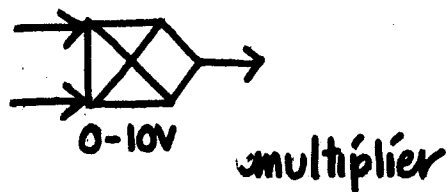
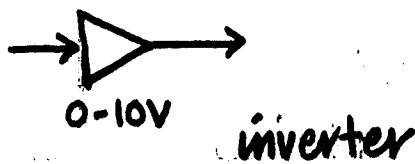
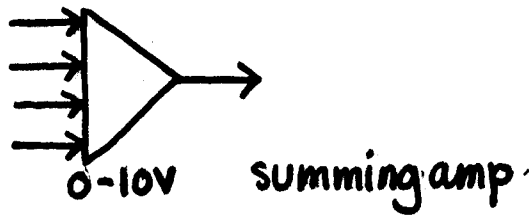

gain pots
bias pots

Rescan

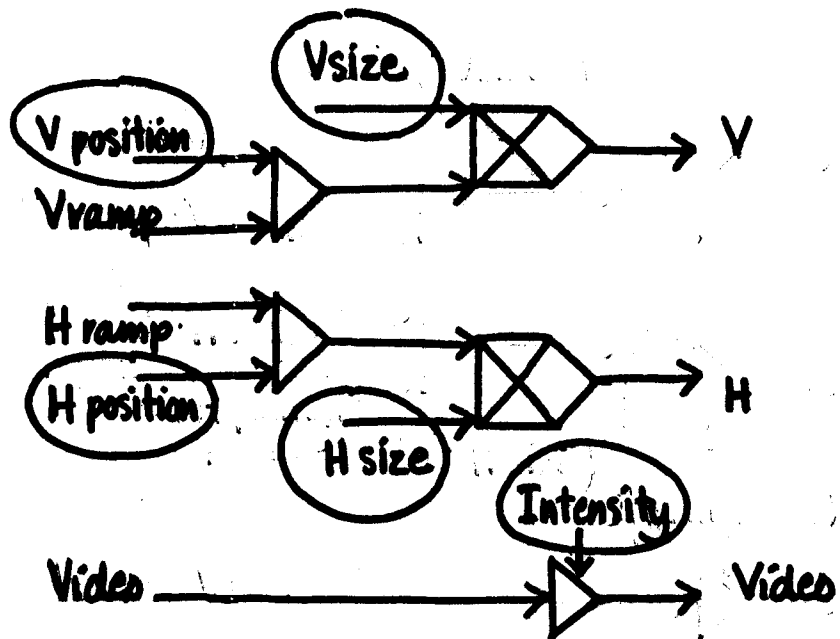

Colorizer

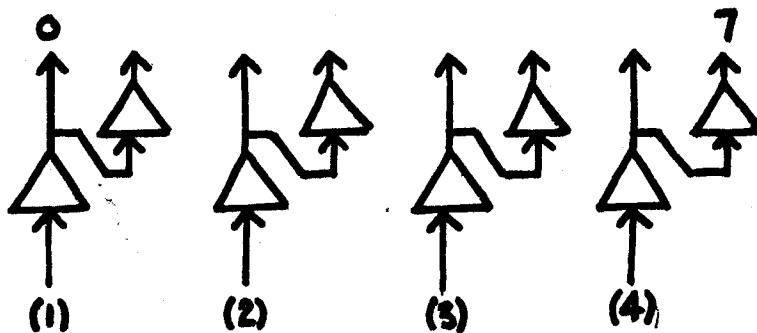
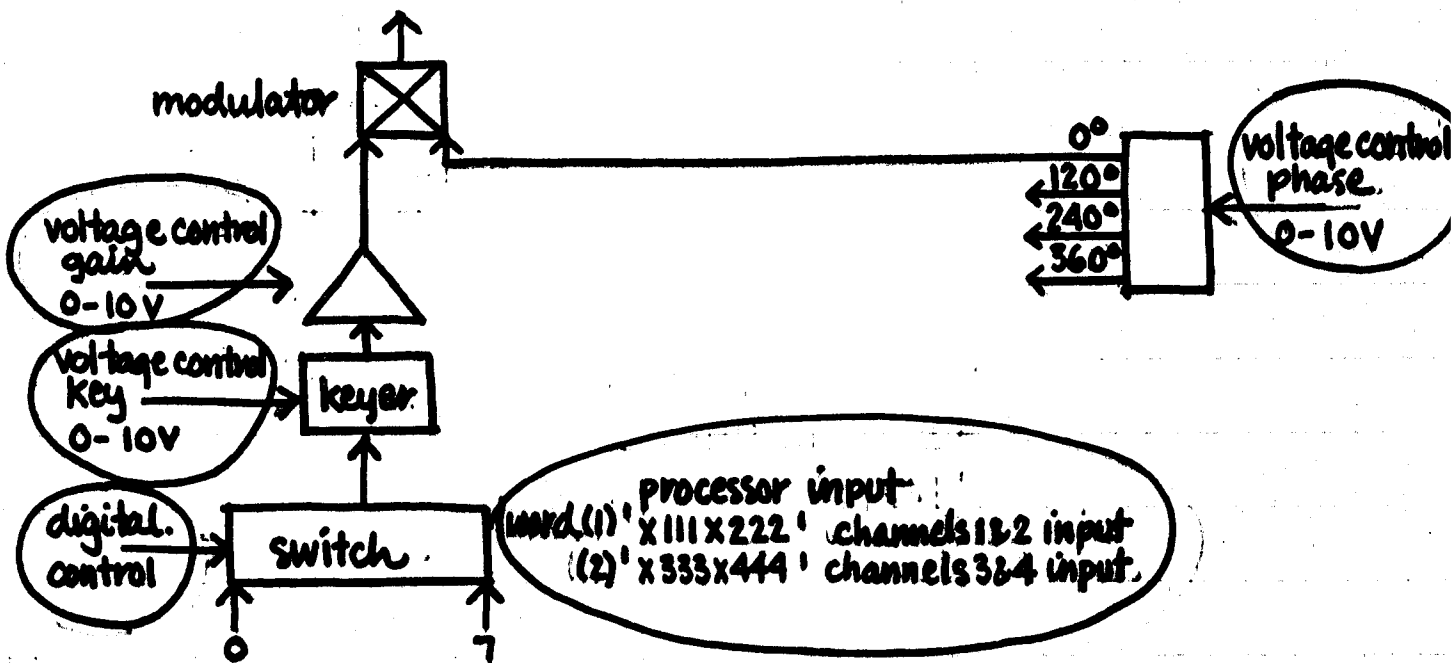
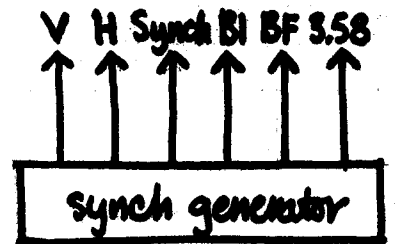
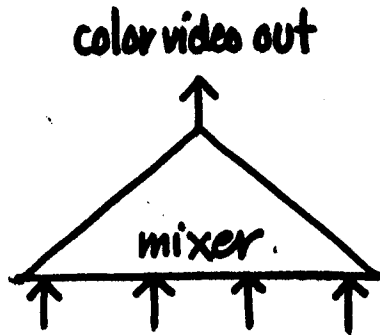

bw video inputs

Walter Wright
 VIDEO
 ART
 1976

As artist-in-residence (1973-75) at the Experimental Television Center, Binghamton, N.Y., I developed the Paik/Abe video synthesizer as a performance instrument. The PAVS accepts as many as 7 b&w video or audio inputs. Video inputs must be in sync; however, prerecorded material is rescanned from a b&w monitor. For pattern generation, audio signals are input directly to the colorizer. The output from the synthesizer is a color image of broadcast quality.

The synthesizer combines several modules including sync generator, cameras, oscillators, colorizer, and the wobbulator. The colorizer is a 7-channel mixer plus colorizer. The input levels are continuously variable from zero to maximum gain using control "pots" on the front panel. Each of the 7 input images is washed with a separate color. These colors are shifted with a single hue control (all channels change color simultaneously). Through the selection of different combinations of colorizer stages and gains, a variety of effects are available, including high contrast (virtually a key), solarization, etc.

The wobbulator is a module unique to the PAVS. It is a modified 7-inch Sony TV receiver and functions as both receiver and monitor. The image is distorted by extra yokes added to the set. In addition to the normal b&w yoke, the wobbulator has a color receiver yoke and a continuous wind yoke. The horizontal portion of the color yoke (H) pulls the image from side to side; the vertical portion (V) rolls up the image top to bottom. The continuous wind yoke (S) produces an "s" curve pattern. The yokes are driven by audio amplifiers which take their input from the audio oscillators. The wobbulator has switches to reverse the image left to right (mirrored) and to turn the image upside down. There are also horizontal and vertical size controls which reduce the image to a line or point.

This past year (1974-75) Susan Wolfson and I performed several original compositions on the PAVS. The compositions are scored using a patching diagram and a fading chart. The notes and images for (two) of these compositions are shown in the accompanying illustrations. Next year Susan and I will be using video synthesizer modules developed by Dave Jones, our technician at the ETC.

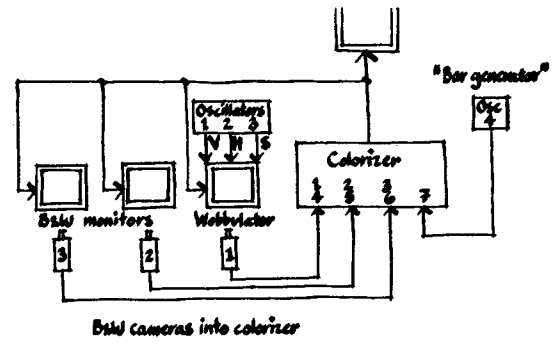

B&W cameras into colorizer

Paik / Abe Video Synthesizer

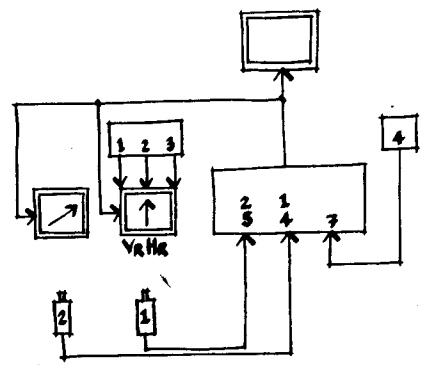

Fit camera 60° clockwise

A Tape for Bridget & Bally

1/75

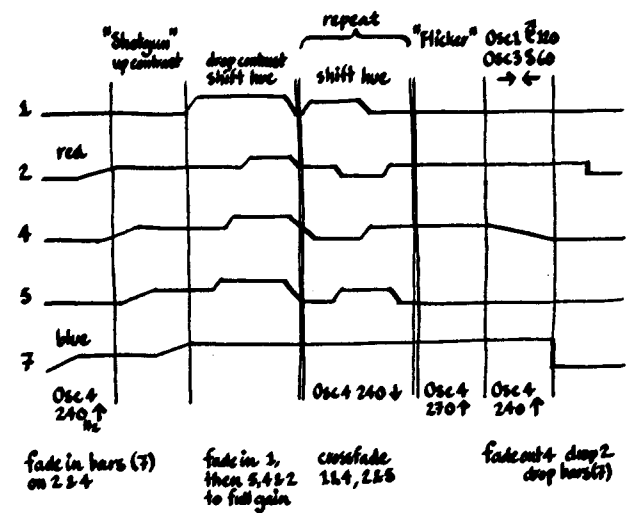

A Tape for Susan

12/74

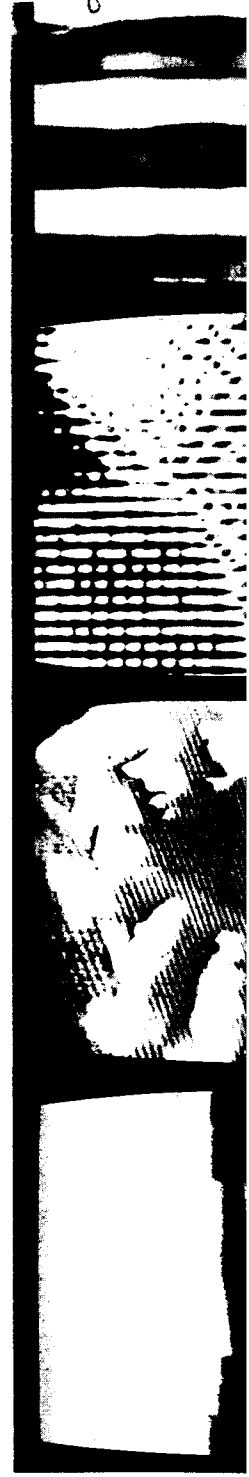

Photos 1-6 from A 7

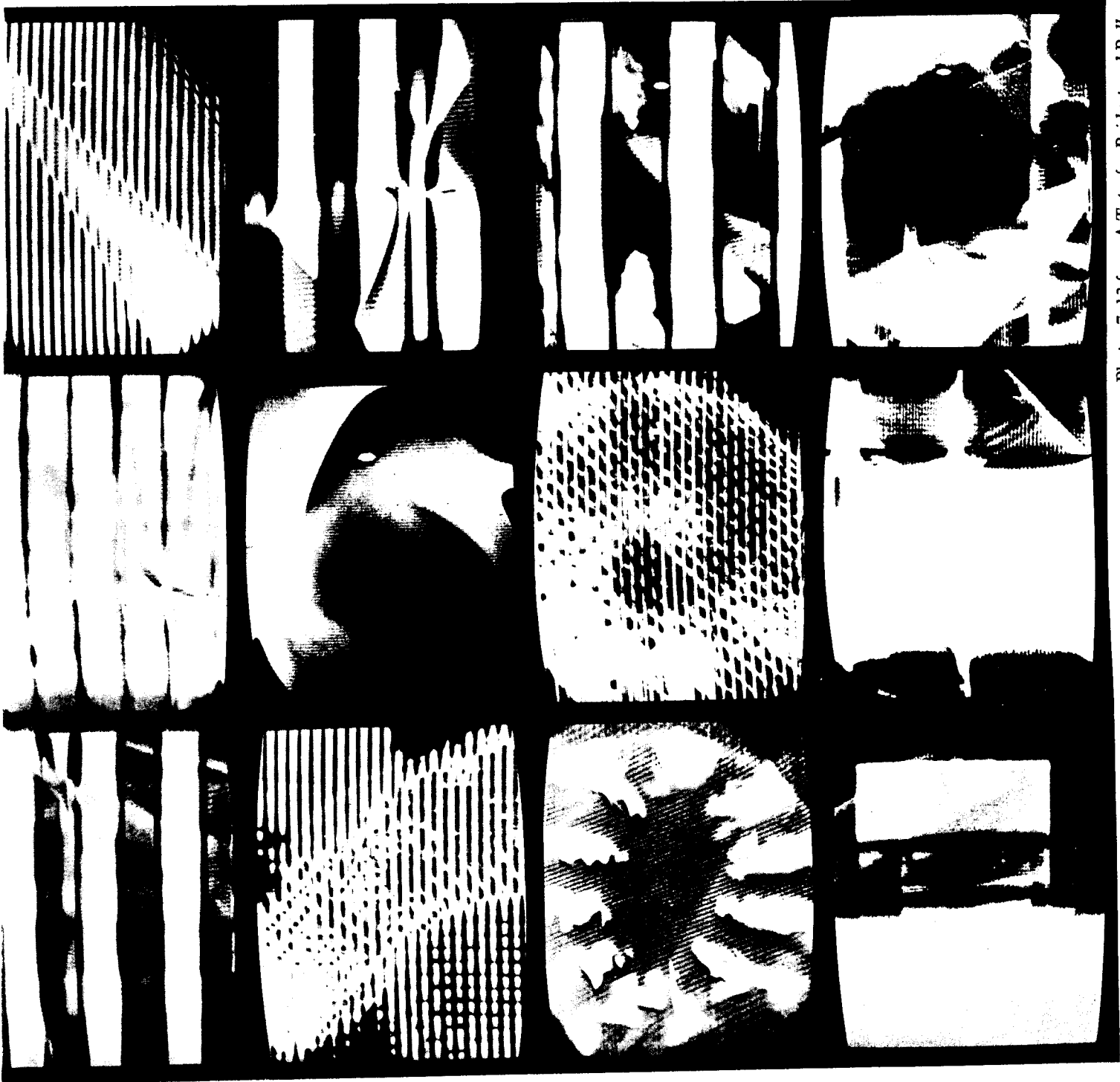

Photos 7-12 from A Tape for Bridget and Bally



Beatles Electroniques (1966-9)



Videotape Study No. 3 (1967-9)



Some film makers have totally converted to video, usually in search of a more efficient sound-sync medium combined with portability and continuous run capability. Others have gained access to television studio facilities with their unique image-processing possibilities to generate videographic material for use in a final film product. A handful, myself included, have pursued inroads into video while still continuing film work.

I have continued in my own work to explore the interfacing of film and video, in the belief that continued brushing against each other by the two media, will assist in polishing and defining their individual essences. Such films as *Aquarian Rushes* (1970), a psychic energy portrait of the Woodstock Festival, and *Ohio Master Arts Program*, now being completed for the Ohio Arts Council, interface kinescoped black and white video with sync sound with time-expanded-and-contracted, original color film footage, composed in camera and through optical printing.

In 1969, with access to video portapak equipment through The Raindance Corporation, I began work with video camera techniques. At the present, I find the Bolex 16mm and the Technisphere-modified Sony portapak equally conducive to the generation of my work, some visions requiring one or the other medium for their ultimate realization, and others requiring continued probing of the intermeshing of both media.

Guest-artist-in-residencies at the WNET Television Laboratory in New York permitted me vision realization with a fully interfaced color-capable system. *The Astrolabe of God* (1972) utilized two color studio cameras, the ability to prepare an electronically colorized feedback tape to serve as sync source and visual input during production, and chroma-key capability, exchanging foreground and background, to crystallize the spiritual base of the tape centered on the unity of within and without in the relationship of the human being to the cosmos. In 1973, *26' 1.1499" for String Player: A Video Realization of the Concert*

processed edited material of previous Cage piece performances filmed from 1966 to 1969, introducing mirror-images, oscillations, reversals, and colorizations, as well as synthesizing other related film material during the live production. Both realizations at the TV Lab occurred in real-time, one-take situations, a premise which continues to interest me as being unique to the video system. Intensive preproduction preparation, as contrasted to the dependency on post-production (editing, opticals, sound synchronization) of film, has always seemed to me germane for proper utilization of the video medium.

Each videotape has presented an opportunity for direct confrontation with both technical sophistications and inherent aesthetic visual considerations. An opportunity to work with an analogue "video computer" system, capable of modifying graphic work wholly or in segments through rotation and oscillation in x, y, and z axes, with the technical assistance of Walter Wright, produced two colorized video works, *The Mirror of Heaven*, six permutations of an astrolabe image into a starfield, and *The Whirling Ecstasy*, transmutations of a whirling dervish figure within three-space. At Synapse/Inner-vision Media Systems at Syracuse, these images were further synthesized with chroma-keyed backgrounds and feedback into *The Mirror of Heaven Remirrored* (1974). Also at Syracuse, work began on a series of interfaces through a "plant response detector," permitting voltage variations from the leaves of a *Gloxiola* to visually modify portions of the video image, resulting in a video collaboration between plant and human in *Experiments in Interspecies Communications No. 1* (1974).

A further realization of the real-time element in video has been my continuing work with the Video Film Collective, originating in New York with work by Jeni Engel, Frank Gillette, Andy Mann, and myself on documentation of the only live concert by Charlie Haden's Liberation Music Orchestra (1972), continued now in southwestern Ohio with a three-camera portable system utilizing live

and others, as p
Collective has p
Baba Ram Dass
ton, two Antioch
tions (Antonin
Arthur Schnitzler
Environmental Scu
Robert Irwin, Ste
Hall, and Rober
problems of mani
cussion situation)
sity, and much wo
Collective (*Seven*
Sado-Masochism,
Tower of Money)

Video, like film
synthesizing medi
In my incarnation
media artist with
bine USCO (1965
imagery refilmed
part of my visual r

Early experiments
television broadca
imposition with o
switching, introdu
gramming analog
nique but with t
ment of "noise,"
inherent in TV re
ing technology. P
multimedia prese
USCO manifeste
entitled *Cathode I*
film maker Briar
35mm slide image
8 and 16mm, an
polarization of the au
uted two channels

In 1965, while fi
Turn Turn, an
translation of kine
inspired by the "e
media theory of M
Paik during his fi
exhibition at the I
his work for ince
Thus was complet
patterning: from
sculpture (Ni

and others, as participating members, the Collective has produced such projects as *Baba Ram Dass at Ghetto's Palace* in Dayton, two Antioch College Theater productions (Antonin Artaud's *The Cenci* and Arthur Schnitzler's *Round Dance*) the *Environmental Sculpture Symposium* with Robert Irwin, Stephen Antonakis, Michael Hall, and Robert Doty (confronting the problems of manipulation of a talking/discussion situation) at Wright State University, and much work with the Living Theater Collective (*Seven Meditations on Political Sado-Masochism*, *Six Public Acts*, and *The Tower of Money*).

Video, like film and other contemporary synthesizing media, has many access ways. In my incarnation as film maker, and multimedia artist with the artist-engineer combine USCO (1965 through 1968), television imagery refilmed in 16mm was an integral part of my visual repertory.

Early experiments in the transmutation of television broadcasting icons involved superimposition with other material, and channel switching, introducing pseudo-random programming analogous to film editing technique but with the added media involvement of "noise," "hash," or interference inherent in TV reception and video recording technology. Part of the touring six-part multimedia presentation "Hubbub" which USCO manifested in 1965 was a section entitled *Cathode Ray*, initiated by Rochester film maker Brian Peterson, consisting of 35mm slide images of TV material, film in 8 and 16mm, and live oscilloscopic interpolation of the audio, for which I contributed two channels of "refilmed TV."

In 1965, while filming material for *Turn Turn Turn*, an exploration in the filmic translation of kinetic and luministic artworks inspired by the "effect rather than content" media theory of McLuhan, I met Nam June Paik during his first New York "TV Art" exhibition at the Bonino Gallery and filmed his work for incorporation into the film. Thus was completed the film's evolutionary patterning: from cybernated light-refracting sculptures (Nicola Schieffer)

which the cathode ray tube emits (Paik).

Thus began the ongoing collaboration between Paik and myself, producing video-films which interface the syntactical qualities of both media, sometimes retinal/kinetic, and most often conceptual/metaphysical. Our "Statement of Objectives," published in the "Expanded Arts Issue" (No. 43) of *Film Culture*, were (1) The study of electronic images composed by purely electronic means directly on the cathode ray screen, (2) the articulation of metaphysics in cinema, aiming to deepen the ontological meaning of monotony, and (3) the transmutation of popular cliché images familiar to any contemporary consciousness, reiterated and metamorphosed beyond their popular meanings into abstraction.

Exemplary of point 3 are such videofilms as *Videotape Study No. 3* (1967-69), in which pretaped press conferences by John Lindsay and Lyndon Johnson are altered electronically and manually by stopping the tape and moving in slow and reversed motion, and by repeated actions; *Beatles Electroniques* (1966-69), with electromagnetically improvised distortions of live and prerecorded takes of the Beatles at Shea Stadium and on the Ed Sullivan show; and *Waiting for Commercials* (1972), in which authentic Japanese-produced TV commercials relentlessly interrupt a media monologue by McLuhan. Indicative of "the articulation of metaphysics" are *Cinéma Métaphysique No. 1* (1966), concerning the concept of scale between the two media, a minute CRT image becoming life-size in the lower right and upper left corners of a full-size film projection; and *Cinéma Métaphysique No. 5* where all the "action" takes place on the edges of the film frame, outside of the *Safe Action Area*, prohibiting "safe" reproduction on black and white and color home receivers.

Other videofilms, like *Electronic Moon No. 2* (1969) and *Electronic Fables* (1972), correlate the gyrating kinetics of electronic video manipulation of the raster with the



26'1.1499 for String Player



The Mirror of Heaven



The Mirror of Heaven Remirrored



Experiments in Interspecies Communication

